



Turnlok[®] 460 System Scaffolding

Turnlok[®] 460 User Guide





Contents

Contents	1
INTRODUCTION	2
Manufacturing and Distribution	2
SAFETY ASPECTS	2
Turnlok® 460 Safety Information	3
TURNLOK® 460 SCAFFOLDING SYSTEM COMPONENTS	5
Standards	5
TUBULAR COMPONENTS.....	6
OMEGA COMPONENTS	9
TURNLOK® 460 SYSTEM STANDARD CONFIGURATIONS	12
THE TURNLOK® 460 NODE LOCKING PROCEDURE	16
ERECTION SEQUENCE	17
INSTRUCTIONS FOR STORAGE, MAINTENANCE OR REPAIR	19
TYPICAL TUBULAR ACCESS LAYOUTS.....	21
TYPICAL OMEGA ACCESS LAYOUTS	22
COMPONENT CAPACITIES	23
BRACING AND TYING IN	26
MAXIMUM WORKING HEIGHTS	27
CIRCULAR ACCESS	42
ACCESS TOWERS.....	43
LOADING PLATFORMS.....	44
STAIR TOWERS	47
BIRDCAGE ACCESS SCAFFOLDS.....	48
RESCUE PLAN.....	50
TECHNICAL SERVICES.....	51



INTRODUCTION

This User guide has been prepared in accordance with the guidance as set out within BS EN 12810-1:2003 Section 9, the NASC Code of Practice and where applicable additional information within associated European Standards. This User Guide is only applicable to Turnlok[®] 460 Basic Access Scaffold's and associated components, other applications such as support scaffolds and access scaffolds outside of the scope of this guide must be designed and calculated by a competent engineer in accordance with the requirements of BS EN 12811. For further technical information see the Technical Data and Support section on Page 51.

Manufacturing and Distribution

Turnlok[®] 460 is manufactured under a quality management procedure in accordance with ISO 9001 Quality Management Systems and the system is documented and implemented in accordance with this. Inspections and testing of the products are carried out by qualified and well trained persons. Each product is checked at every production stage from incoming materials to final finishing and delivery as per the relevant inspection forms and specific customer needs. Inspection forms are laid down to meet the dimension requirements, which are determined on the basis of design drawings. The components and system configurations all undergo the necessary testing and calculation checks in accordance with the current codes of practice. All fixtures, testing equipment, measuring instruments and gauges are calibrated at planned intervals. Our branches work under a regime of constant monitoring of our components.

SAFETY ASPECTS

All scaffold erectors must wear a harness while erecting, dismantling and working on any scaffold in accordance with the requirements of the current work at height regulations. They must follow site, local and national occupational health and safety regulations and the requirements of SG04:10 from the NASC in Britain.

Turnlok® 460 Safety Information

1. Ensure that scaffold is erected on a suitable foundation that is capable of resisting design loads.
2. Platform units shall be locked against unintentional lifting.
3. Do not overload the scaffold with bricks and other materials. Load materials as close to the Standard as possible.
4. Every area for access and working shall be so arranged as to provide a convenient working place, and to:
 - protect people from the risk of falling;
 - provide safe storage of materials and equipment;
 - protect those below from falling objects.
5. Ensure that working and access areas are safeguarded by a side protection consisting of at least two guardrails and a toeboard.
6. Side protection shall be secured against unintended removal.
7. The side protection should not be provided by cladding on its own.
8. The stairways and ladders shall be secured against unintentional loosening and shall have a slip resistant surface.
9. The platform surface shall be free from trip hazards.
10. Working areas shall be as level as practicable.
11. The gaps between platform units shall be as small as possible but not exceeding 25mm.
12. Lateral stability shall be provided by tie members to the adjacent building or structure. Any part of a building or structure used to support the scaffold shall be capable of supporting the maximum intended load to be applied.
13. Provide adequate bracing to give stiff vertical plane of scaffold.
14. Connections between separate parts shall be effective and easy to monitor. They shall be easy to assemble and secure against accidental disconnection.
15. Inspection of the scaffold shall be carried out by a competent person before each use and a report issued/filed.
16. No ties should be removed without approval, and if necessary, the prior fixing of alternative ties or bracing should take place to ensure the continuing safety of the scaffold.



RULES OF USE

- Never remove ties.
- Never remove ladders
- Never remove components or adapt a certified scaffold.
- Never remove bracing.
- Never remove guardrails, toe boards or brick guards.
- Never create gaps in the working platform by removing scaffolding boards.
- Never work on or use scaffolds which are in the process of being erected or dismantled.
- Never undermine the scaffold by digging trenches or foundations under or adjacent to it.
- Never add sheeting or debris netting to a scaffold without the approval of the scaffolding designer.
- Never forklift loads directly onto an access scaffold, instead use a suitably designed loading tower.
- Never allow site vehicles to run over scaffolding materials; damaged scaffold boards cause accidents.
- Never allow site vehicles to run into a scaffold. Bent tubes could lead to collapse of the structure even the slightest misalignment will significantly reduce the scaffolds capacity.
- Never jump on to planks or platforms.

TURNLOK® 460 SCAFFOLDING SYSTEM COMPONENTS

Standards

The TURNLOK® 460 standards are the vertical elements of the system. They are manufactured from 48.3mm diameter by 3.2mm wall thickness, high yield steel tube.

They incorporate fixed lower cups at 0.5m vertical centers with a captive free upper cup to form horizontal connections to up to four other components from the system. The lowest connection is some 80mm from the standards base and there is a fixed spigot to the top to allow connections to other standards with a locking nut to allow the development of tensile forces.

Code	Length (m)	Overall Length (m)	Weight (kg)
VRS50a	1.0	1.150	5.8
VRS50b	2.0	2.150	11.2
VRS50c	3.0	3.150	16.5

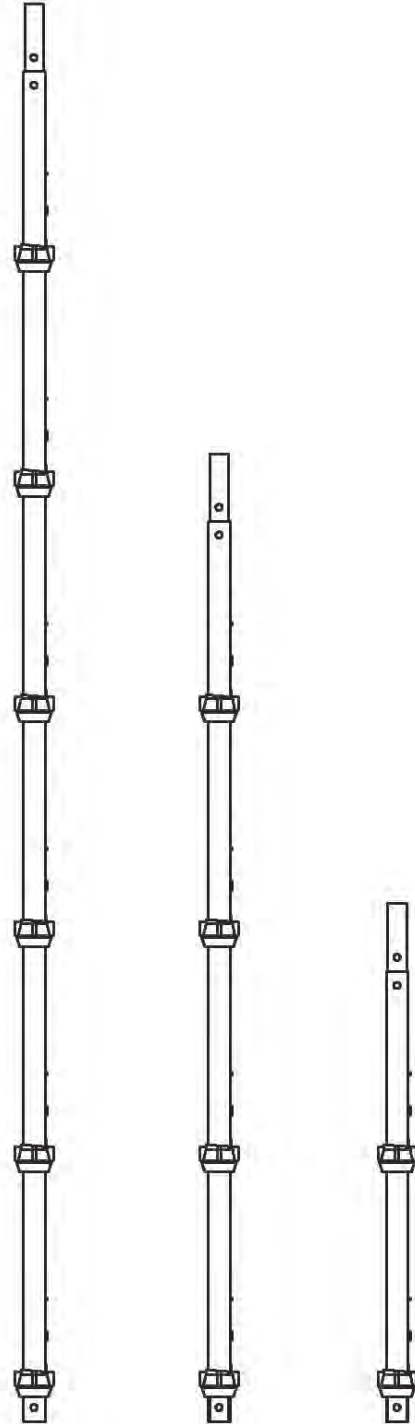



TUBULAR COMPONENTS

Tubular Ledgers and Transoms

These are the horizontal elements of the system scaffold. They are available in differing lengths to suit the standard system configurations. They are made out of the same 48.3mm diameter and 3.2mm thick wall, high yield steel, as the standards and are fitted with a Forged steel end blade which is located into the standard connector cups. The 1.3m long transoms are used as the transoms or ledgers to small and return bays whereas the longer options form the typical bay sizes of the system for access scaffolds in 1.8m or 2.5m lengths.

The tubular ledgers are also utilized as the guardrails for the systems working lifts.



Code	Nominal Length (m)	Overall Length (m)	Weight (kg)
VRS52a	0.6	0.534	2.1
VRS52b	0.74	0.674	2.7
VRS52c	0.9	0.834	3.3
VRS52d	1.0	0.934	3.7
VRS52e	1.2	1.134	4.5
VRS52f	1.25	1.184	4.7
VRS52g	1.3	1.234	4.9
VRS52h	1.6	1.534	6.1
VRS52i	1.8	1.734	6.9
VRS52j	2.0	1.934	7.6
VRS52k	2.5	2.434	9.5
VRS52L	3.0	2.934	11.5

Intermediate Transoms

Used in conjunction with the tubular transoms to form intermediate support to the standard 38mm scaffold boards to ensure they comply with the manufacturers recommendations for maximum span for the proposed loading. They use the same sized steel tube as the standards with steel U plates to each end to fit over the ledger tube elements. The larger U plate comes with a steel plate locking wedge to prevent movement when in place.



Code	Length (m)	Overall Length (m)	Weight (kg)
VRS54a	1.05	1.055	5.4
VRS54b	1.2	1.250	6.1
VRS54c	1.3	1.350	6.6
VRS54d	1.8	1.850	9.0
VRS54c	0.9	0.950	5.0

Vertical Braces

These component form the bracing to the face of the access scaffold. They are formed out of 235N/mm² yeild strength 48.3mm diameter by 3.2mm thick steel tube. The ends are pressed and a riveted swivel blade is attached to fit into the standard connector cups.

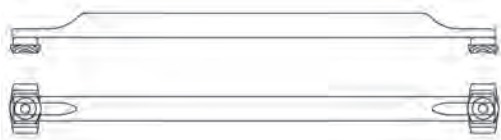

Code	Bay Size (m) H x L	Overall Length (m)	Weight (kg)
VRS53a	1.5x3.0	3.354	12.1
VRS53b	3.0x2.0	3.606	13.0
VRS53c	2.5x2.0	3.201	11.5
VRS53d	2.5x1.5	2.915	10.7
VRS53e	1.8x2.0	2.691	9.8
VRS53f	1.8x1.5	2.343	8.7
VRS53g	1.3x2.0	2.385	8.8

Intermediate Inside Board Transoms

Used in the same manner as the Intermediate Transoms when an internal board is required to the working platform. There are options for one or two internal boards. The extension piece is a tube as the main tube welded to the larger U plate with a board stop plate to its outer edge. To prevent any uplift where the internal boards are heavily loaded relative to the main working platform the smaller U plate is rotated to make a C plate with the open facing outwards. The two board component has a small U plate to its internal board end to fit over the hop up bracket ledger.



1 Internal Board



2 Internal Boards

Code	Overall Length (m)	Item	Weight (m)
VRS55	1.62	1 Board	9.0
VRS56	1.895	2 Board	11.5

Internal Board Support

This item supports the scaffold board at the standard position. It is a standard tube specification with a connector blade to one end to fit into the standards connector cup and a flat to the other end to retain the board. The component must be used with all 4 connectors in the cup present to prevent rotation.



Code	Overall Length (m)	Item	Weight (kg)
VRS58	0.26	1 Board	1.5

Internal Board Bracket (Hop-up) - Tubular

To enable the erection of 2 and 3 internal board arrangements to the working platform the system has a bracket component that fixes to the standard with a connector blade at the platform level and a shaped steel plate to the bottom member to fit around the standards profile. There is a small standard to the brackets other end with a connector cup to allow the fixing of ledgers and standards for handrails if required.

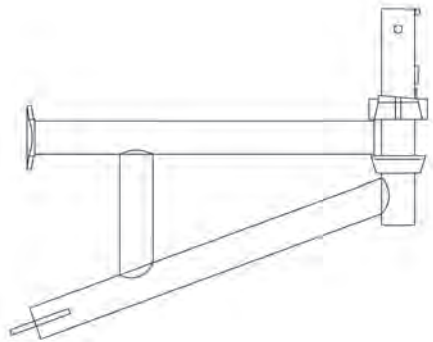

Code	Overall Length (m)	Item	Weight (kg)
VRS59	0.585	2 Board	6.3
VRS60	0.815	3 Board	7.7

Adjustable Base Jacks

These fit into the bottom of the lowest standard and are used to level the scaffold. They have a maximum extension of 0.5m but a minimum of a third of the threaded tube must be within the standard to remain stable. They have a maximum load of either 40kN or 60kN for the heavy duty version.

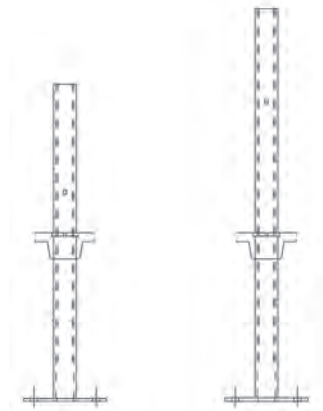

Code	Height (m)	Max Adj. (m)	Weight (m)
VRS97	0.525	0.35	3.0
VRS98	0.65	0.5	3.4

Return Device- Tubular

This is used to create a fly-past return to the access scaffold (see page 18 - Corner Returns). The blade fixes into the standard connector cup and the U-plate is placed over the 90 degree access ledger to connect the two elements.

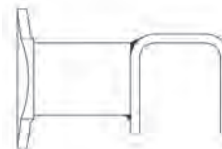

Code	Weight (kg)
VRS71	1.15

OMEGA COMPONENTS

Omega Transom

The Omega Transom is cold formed from a sheet of steel and has two blades welded to each end which will be placed into the standard connector cups as an alternative to the tubular transoms. The profile allows the 63mm deep battens, steel or timber, to sit on the bottom flanges to provide a clear span to the decking increasing the headroom.

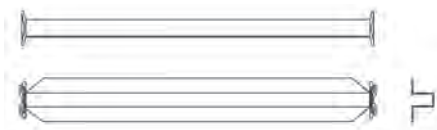

Code	Nominal Length (m)	Overall Length (m)	Weight (kg)
VRS51e	0.6	0.532	3.1
VRS51a	0.8	0.732	3.9
VRS51f	0.9	0.832	4.6
VRS51b	1.3	1.232	6.6
VRS51c	1.8	1.732	10.0
VRS51d	2.5	2.432	24.8

Omega Ladder Access Transom

The component is used to form an opening in the battened working platform for a ladder access. It utilizes a half coupler to one end and a U-plate to the other to fix and hook respectively to the two tubular ledgers. Cut battens are then supported into the two board wide upstand plate to maintain the working lift away from the ladder opening.

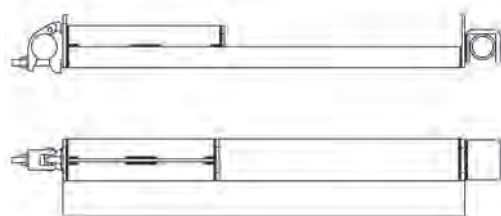

Code	Nominal Length (m)	Weight (kg)
VRS96	1.3	9.3

Tube/Omega Return Transom

This component is the substitute for the return device of the tubular systems allowing the corner fly past connection to be used.

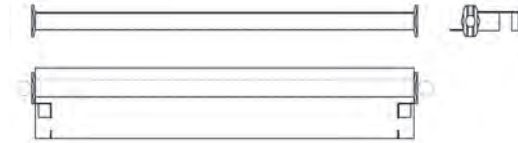

Code	Nominal Length (m)	Weight (kg)
VRS68	1.3	8.6

Omega Internal Board Support

The component allows the forming of a support at the standard for and internal boards extension to the working platform. As the tubular system the use of this element will require the connector cup to be fully filled with 4 components

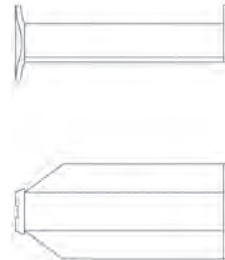

Code	Overall Length (m)	Weight (kg)
VRS61	0.267	2.3

Omega Inside Board Bracket (Hop-up)

Designed to form a 2 and 3 board internal extension with the Omega system. As the tubular bracket but with an omega transom length to the horizontal element it too fits into the standard connector cup with the formed steel plate to the bottom brace with a stub standard for a handrail option and a connector cup for a ledger connection.

Code	Overall Length (m)	Item	Weight (kg)
VRS62	0.585	2 Board	6.6
VRS63	0.815	3 Board	7.6

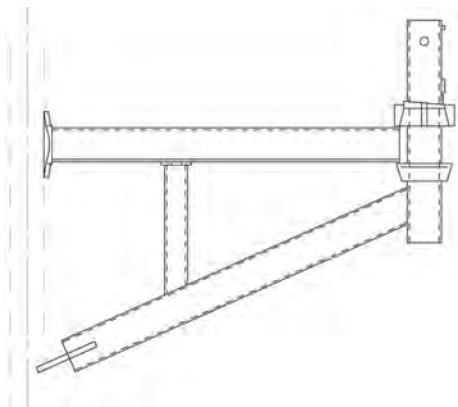

Omega Corner Unit

This component supports the internal boards to an internal corner arrangement. The two blade connectors fit into the ledger connectors to the stub standard of the hop-up brackets. The component comes with 2 and 3 board options and is then in filled with cut battens.

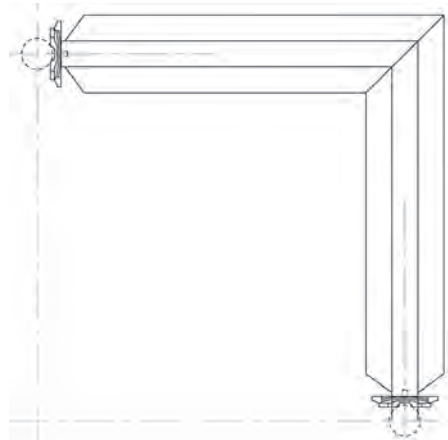

Code	Item	Weight (kg)
VRS99	2 Board	6.6
VRS100	3 Board	9.3

Timber Batten

The Timber Battens are used to form the working platform for the Omega section system. The battens are 63mm deep and 225mm wide and span the length of the scaffolds bay size. The Battens are manufactured in accordance with BS2482 and the weights are based upon a moisture content of 20%.



Code	Nominal Length (m)	Overall Length (m)	Weight (kg)
VRSTB1	1.3	1.25	9.5
VRSTB2	1.8	1.75	13.0
VRSTB3	2.5	2.45	18.0

Steel Batten

The steel batten is a galvanized steel profile cold formed from a single sheet to form a 225mm wide and 63mm deep section. The top plate is punched and profiled to provide a non slip surface.

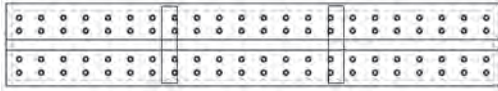

Code	Nominal Length (m)	Overall Length (m)	Weight (kg)
VRS01a	1.3	1.25	9.5
VRS01b	1.8	1.75	13.0
VRS01c	2.5	2.45	18.0
VRS01d	2.5 HD	2.45	25.0

OMEGA Timber Batten Toe Board Clip

For use with timber battens only. Locates around the standards and sits on the top hat section of the Omega Transom.

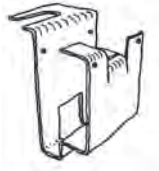

Code	Approx. Size (mm)	Weight (kg)
VRS101	150 x 120 x 171	1.0

OMEGA Steel Batten Toe Board Clip

For use with steel battens only. Locates around the standard and locks the toe boards into position.



Code	Weight (kg)
VRS102	1.0

Swan-neck Standard

This item is used as a fixed puncheon for receiving guardrails when creating an access opening to a working or boarded platform and is used in conjunction with the Ladder Safety Gate.

The Standard hooks over the tubular ledger at the platform level and is securely fixed with a wedge coupler to an additional ledger fixed to the node below.

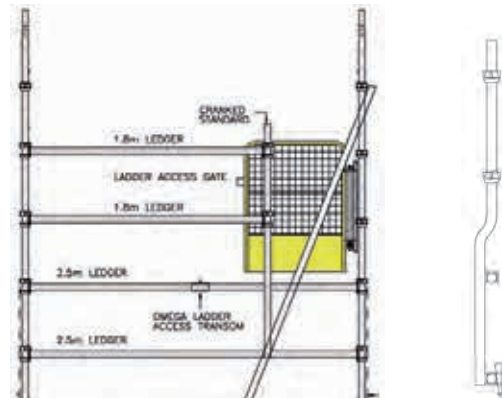

Code	Length (m)	Weight (kg)
VRS103	1.720	10.0



TURNLOK® 460 SYSTEM STANDARD CONFIGURATIONS

Lift Heights

All lift height are to be 2.000m to comply with the system configuration certification. However, Lift heights of 1.5m for progressive brickwork scaffolds are permissible also.

Tubular Working Lift Configurations

2.5m Bays

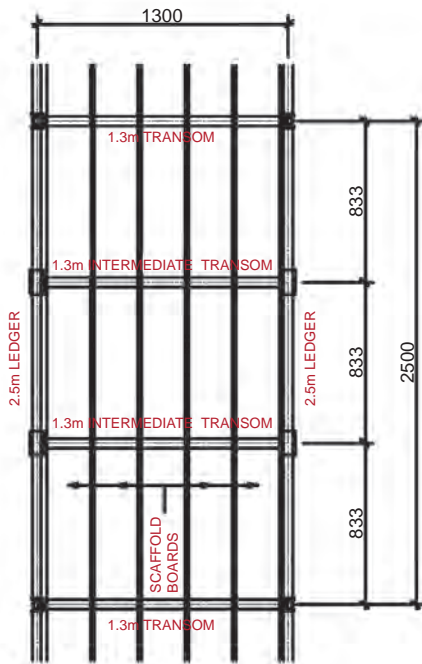

LC4 - 5 - 0

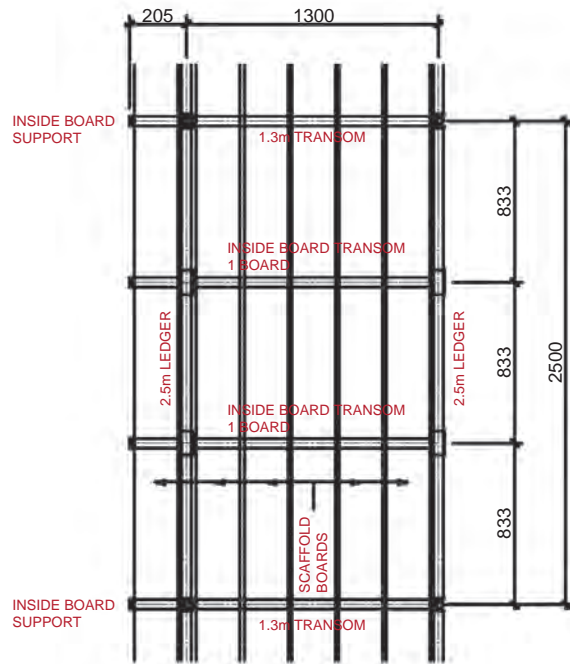

LC4 - 5 - 1

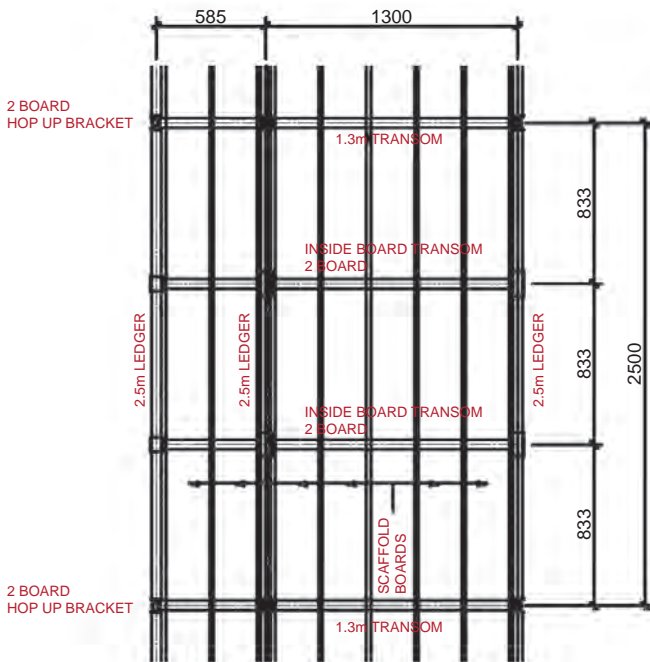

LC4 - 5 - 2

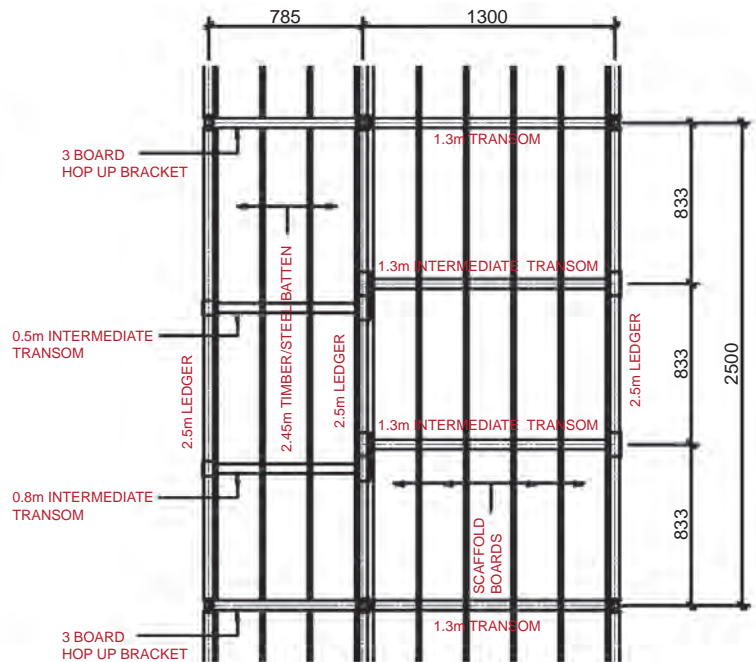

LC4 - 5 - 3

TURNLOK® 460 SYSTEM STANDARD CONFIGURATIONS

Tubular Working Lift Configurations 1.8m Bays

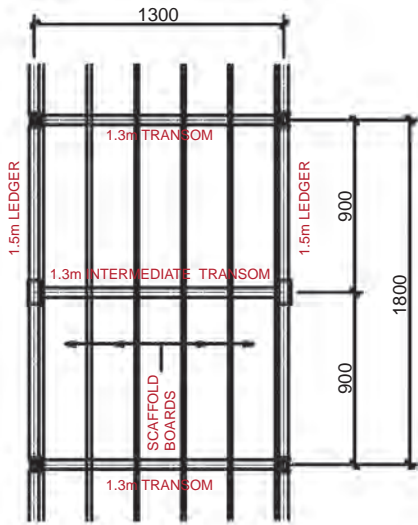

LC4 - 5 - 0 S

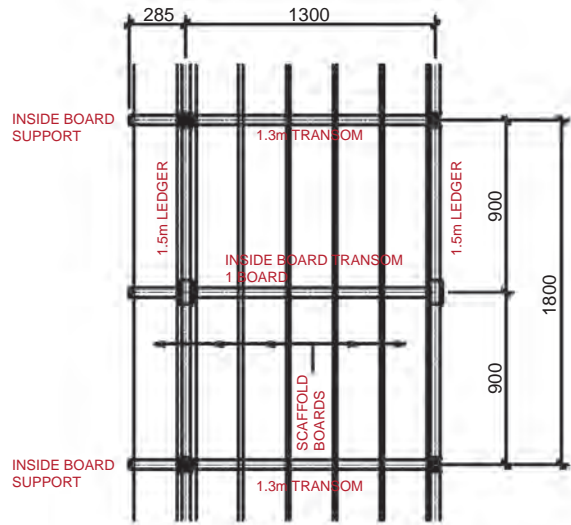

LC4 - 5 - 1 S

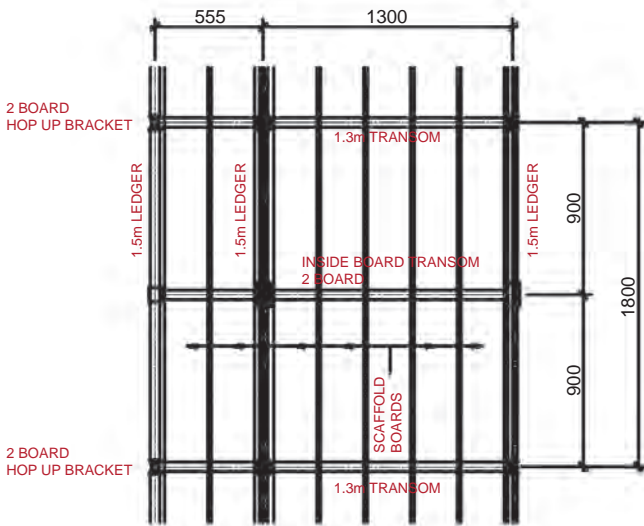

LC4 - 5 - 2 S

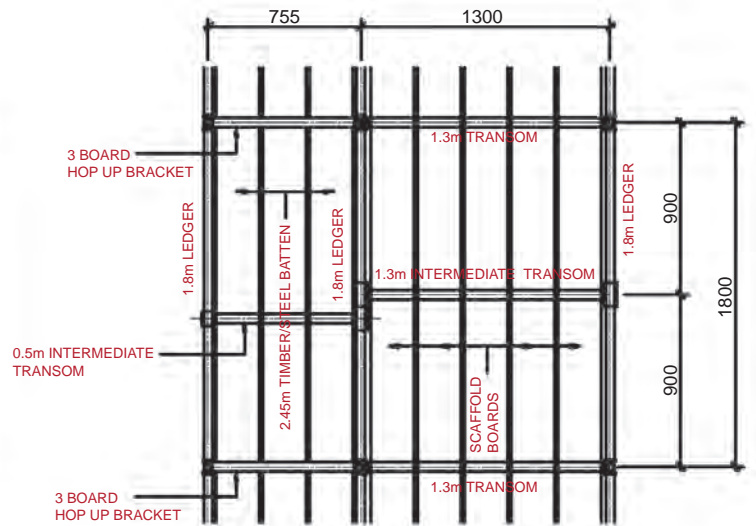

LC4 - 5 - 3 S



TURNLOK® 460 SYSTEM STANDARD CONFIGURATIONS

Omega Working Lift Configurations 2.5m Bays

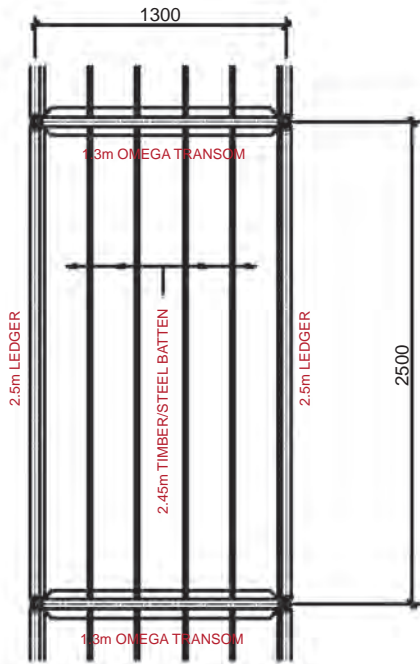

LC4 - 5 - 0

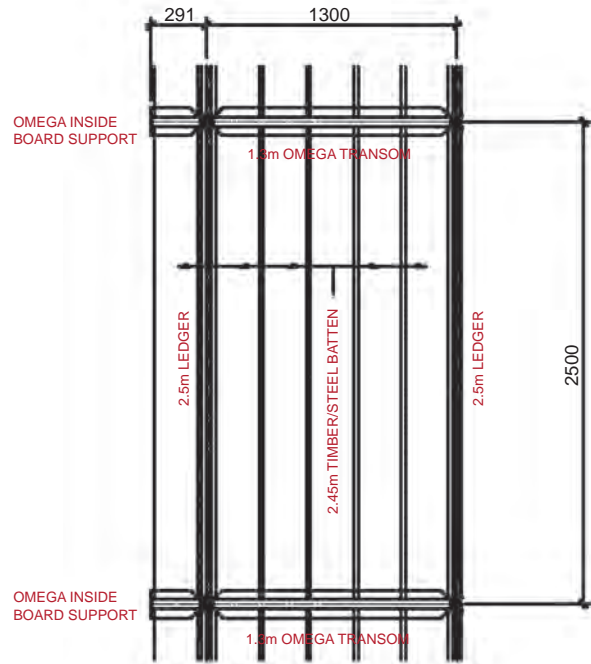

LC4 - 5 - 1

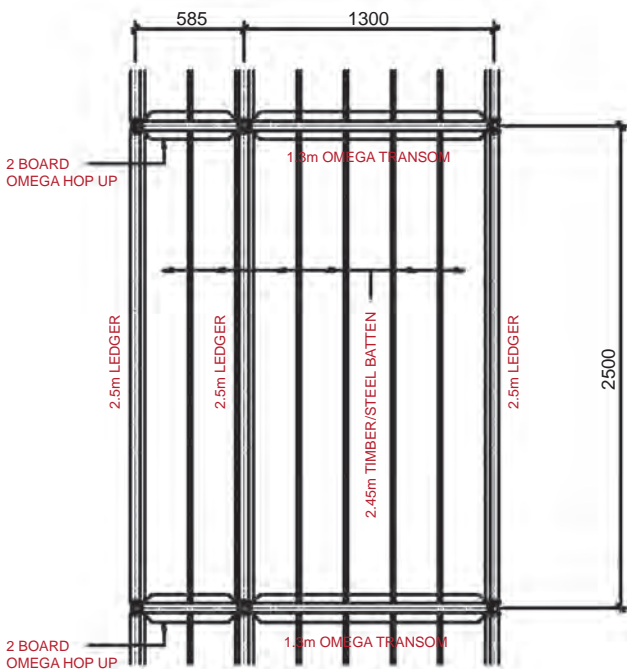

LC4 - 5 - 2

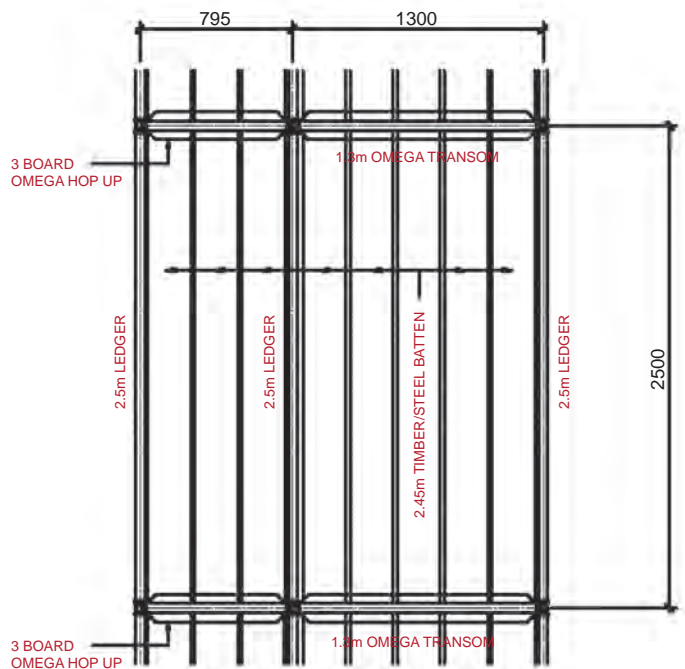

LC4 - 5 - 3



TURNLOK[®] 460 SYSTEM STANDARD CONFIGURATIONS

Omega Working Lift Configurations 1.8m Bays

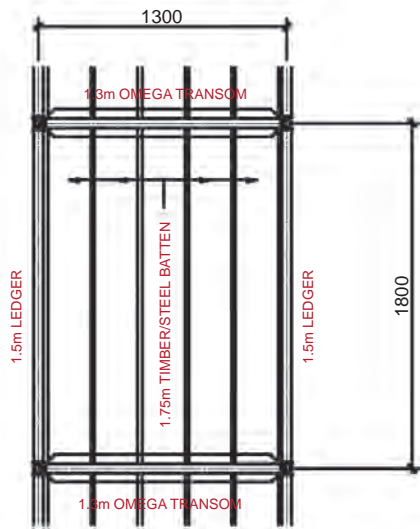

LC4 - 5 - 0 S

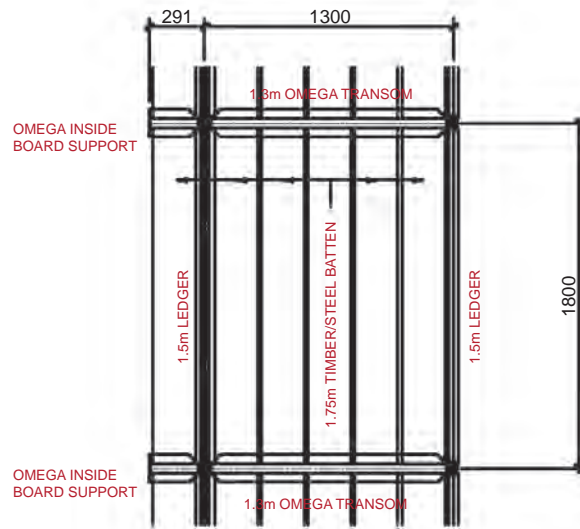

LC4 - 5 - 1 S

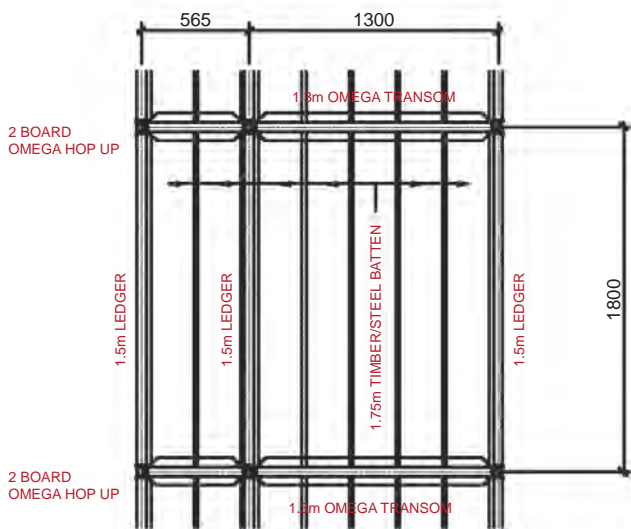

LC4 - 5 - 2 S

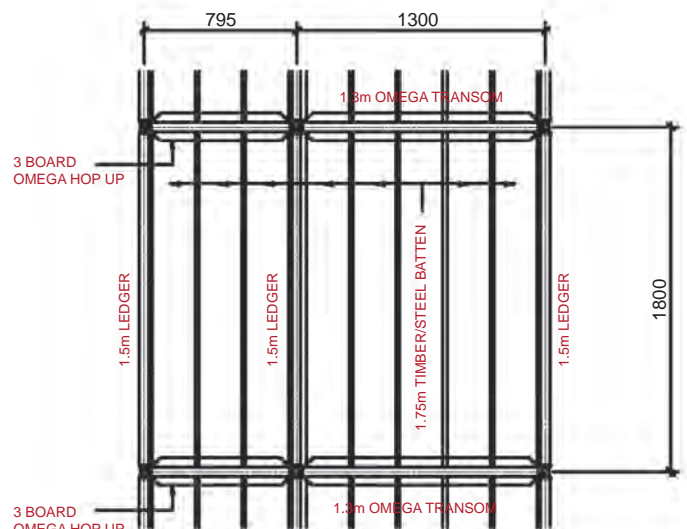

LC4 - 5 - 3 S



THE TURNLOK[®] 460 NODE LOCKING PROCEDURE

The scaffolding systems stability and simplicity of erection is reliant upon the design of the node point. This allows the horizontal ledgers and transoms to be quickly and easily located into the standard and to be safely secured in place without the need for separate couplers secured by nut and threaded bolts.

The standards have a fixed lower node element which are located at 500mm vertical centers into which four components can be fixed using a high tensile blade end to the components.

The blade is then clamped in place with a top cup which can slide vertically along the standard. Using a cam action onto an appropriately spaced steel welded flat on the standard the cup can be rotated down onto the top of the blade and secured with a hammer blow. This provides a positive rigid connection between the top node elements and the component blade. This locking device makes Turnlok[®] 460 faster to erect and dismantle any any other type of system.

Once the initial base lift is levelled subsequent lifts are automatically placed without the need for additional adjustment.

Without loose components, the system is both economic and robust.

All components are galvanized both inside and out for resistance to corrosion and damage.

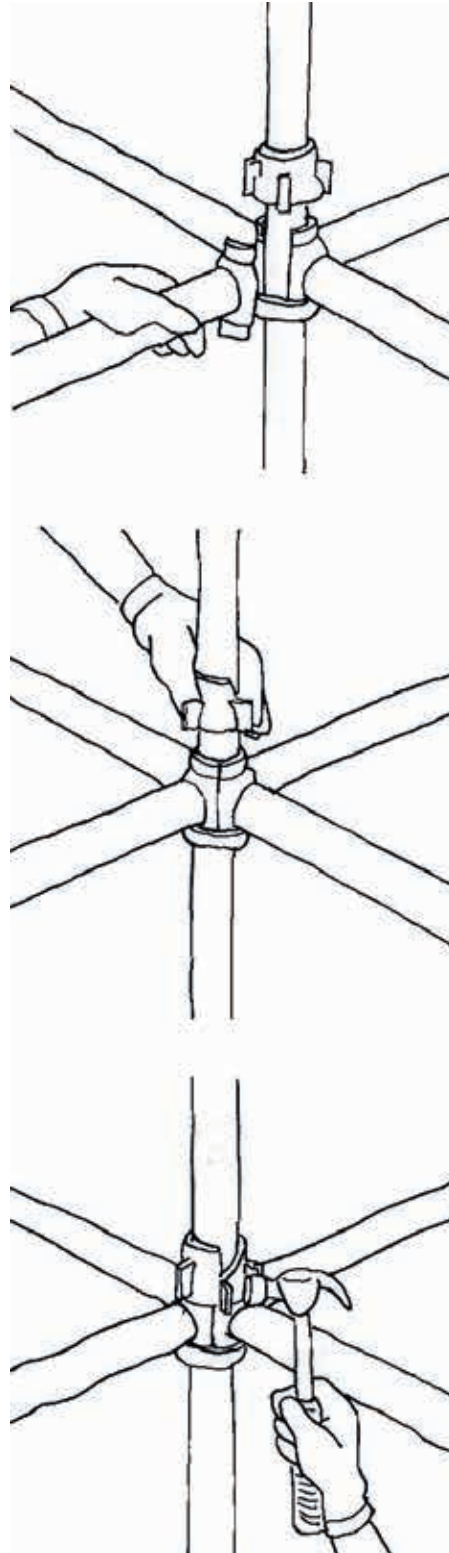

ERECTION SEQUENCE

For use with conventional scaffold boards

1. Lay out the components about to be used in approximate positions. Mount an adjustable jack on a sole plate and place a standard over the jack allowing 125mm thread adjustment. Start at the highest ground point.
2. Hold the first two standards and locate the Transom as a foot tie. Roughly level the Transom, install the Ledgers, and loosely tighten the top cups, which rotate. Use staggered standards on the outside to allow a handrail on the next lift.
3. Install two further standards, insert Ledgers and Transom and loosely tighten the top cups. Using a spirit level, adjust the jacks in rotation on three sides. Continue and install further bays of foot ties and progressively level.
4. Install next working level lift using Ledgers and Transoms and tighten top cup with a firm hammer blow. This lift will be self-levelling and require no further adjustment. Fit intermediate Transoms to support boards at 1.2m centres (See Board Specification). Boards should be supported at 150mm from end of board.
5. Install Ledgers at 500mm and 1.0m pockets to provide a double handrail. A toeboard should be installed on each working platform.
6. A swivel face brace should be installed. As only one blade can be located at each node point, parallel bracing is used. Face bracing is required to the full height every 8 bays (20m).

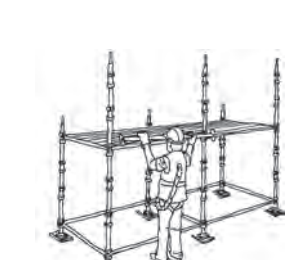
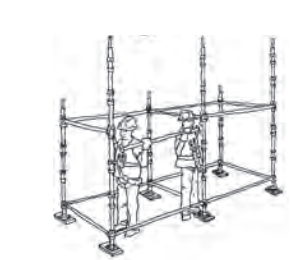
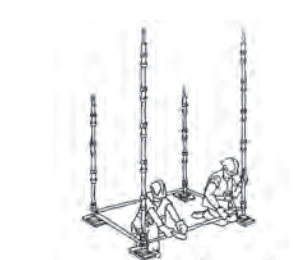
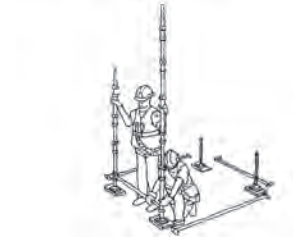
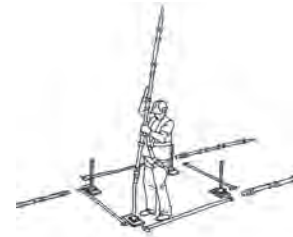



For use with TURNLOK® 460 OMEGA Battens

Complete the structure in the same way using OMEGA Transoms, which support steel or timber battens. No intermediate support is required. A range of inside boards and Hop-Ups are available to widen the scaffold and provide additional platform to the face of the building.

Ledger Bracing and Plan Bracing

The TURNLOK® 460 node fixing provides an extremely rigid connection and Ledger bracing is not normally required. This allows free walkway through the scaffold. Ledger bracing may be specified by your temporary works designer for tall structures and where increased capacity is required. Plan bracing is not generally required unless specified.

Ties

Ties should be physically installed as soon as practicable. See also notes in the tie pattern section.

Corners and Returns

Rigid corners can be formed using square 1.3m bays. Alternatively, bays on the adjacent elevation can overfly past using Return devices or fixed with regular scaffold double couplers. Care must be taken to ensure continuity of handrail and toeboards. See typical layout in this guide.

Dismantling of TURNLOK® 460 System Scaffold

It is essential that the sequence for dismantling is the same process as for erection in reverse. Care must be taken to ensure that the same safety precautions are applied at all stages of the dismantle. Restraint and protective measures should be used at all times (see page 4). Before dismantling takes place the structure should be inspected for correct erection and identification where adaptation or alteration may have taken place. Four board wide temporary platforms should be installed along with temporary handrails during the dismantle.

INSTRUCTIONS FOR STORAGE, MAINTENANCE OR REPAIR

1.STORAGE

1. Prefabricated components shall be stored, if possible, under a suitable cover, protected from weather in a dry location. They shall be exposed to good ventilation. They shall be supported during storage so as to avoid permanent set.
2. At the work site, provide enough space to drive the forklift and other vehicles otherwise there are chances of damages to the components.
3. Tags should be used to differentiate good components from the damaged components.
4. All the components shall be stored in a marked storage place.
5. Do not stack any items on the road to avoid injury to passersby.

2.MAINTENANCE

1. Before allowing people or material on the scaffold structure ensure that it has been erected correctly and complies with the user's requirements.
2. Ensure that all people using the scaffold are aware of the purpose for which it is intended to be used and the maximum loading to which it can be subjected.
3. Ensure that users understand that any unauthorised modification to the scaffold or removal of components other than those which have been specifically designed for it will materially weaken the scaffold and create a safety hazard.
4. Carry out regular inspections to check that components have not been removed or damaged, or that components have not been removed and replaced incorrectly.
5. Alterations or extensions (e.g. removal or repositioning of ties, removal of guardrails or handrails, the addition of boarded platform, sheeting, debris netting, etc) should only be carried out within the restrictions set out in this handbook or under the direction of a competent designer who is prepared to accept the onus of his modifications.
6. Provide barriers and warning notices to prevent access to incomplete sections of scaffolding.



7. Ensure that safe access and egress routes are provided to all working platforms, and that such routes, including ladders or preferably stairways, are kept clear.
8. Do not overload platforms; use properly designed loading towers and ensure that crane and forklift drivers understand loading restrictions on each part of the scaffold structure.
9. Where necessary ensure that all areas below scaffolds in use are marked so that site personnel can avoid the area. If the area has to be accessed then the site personnel should be made aware of the potential risks or hazards.
10. Because of the increased use of mechanical lifting plant on site there is an increased possibility for scaffolding components to become found / caught. When using cranes or other mechanical lifting devices near any scaffold structure care should be taken to ensure that nothing catches under any part of the scaffold otherwise uplift could occur with potentially dangerous consequences.

3.REPAIRS

If any scaffold gets damaged, inform the scaffolding contractor or authorised person then repairs can be carried out. The repaired item is only to be used after the approval of said competent person.

4.TRANSPORT

During transportation it should be ensured that the prefabricated components are loaded properly and securely tightened to the vehicle to avoid dropping of components during travelling. Loading and unloading should be carried out under the supervision of a competent person to avoid damage to the components.

TYPICAL TUBULAR ACCESS LAYOUTS

Corner Returns

To form corner returns with the TURNLOK® 460 system scaffold there are two potential methods:

1. Small Bay (or Square Bay) Return
2. Fly –Past Return.

Small Bay Return

This is formed with a 1.3m by 1.3m bay, as illustrated below:



Fly-past method

This is used where a corner detail falls within a non-standard bay. For tubular transoms the Return Device is used.

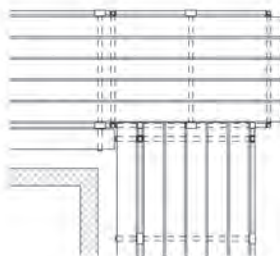

External corners with internal boards will use intermediated transoms with internal board element next to the corner with the truncated boards taken back to the hop-up bracket at the next standard.

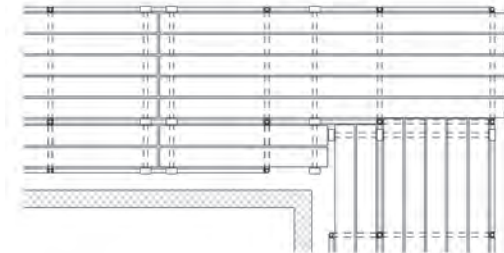

Internal corners can be formed with both the small bay and the fly-past method. Internal boards require the use of other components from the range.

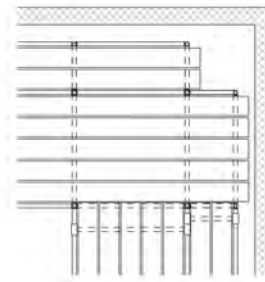

2 Board Internal at Internal Corner

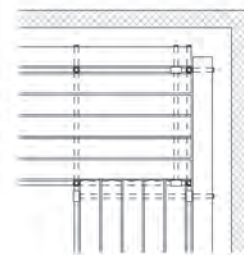

1 Board Internal at Internal Corner



TYPICAL OMEGA ACCESS LAYOUTS

The OMEGA system uses OMEGA transoms and Omega Battens to form the working platform. The battens can be either steel or timber and require no intermediate supports. Omega Transoms are used at the working lifts but the remaining lifts still use tubular transoms and they are also used for the handrailing.

Corner Returns

Both the Small Bay and the Fly-past methods are still used. The fly-past method uses the Omega Return Transom which is located over the adjacent fly-past ledger.

Internal corners with multiple internal boards use the Hop-up brackets and the Omega corner piece.

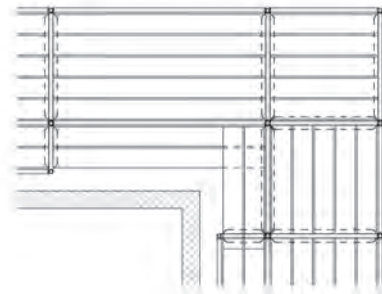

External corners use the Hop-up brackets with an additional 1.3m bay to minimize the gap between the platforms.

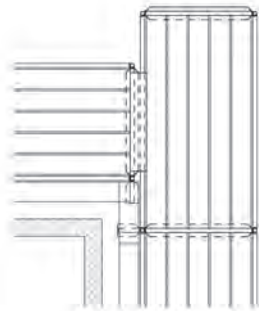

Internal corners with one internal board uses the Omega one board supports into the standard.

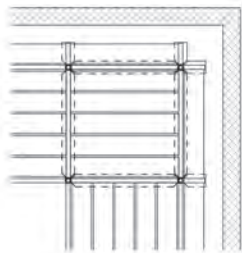
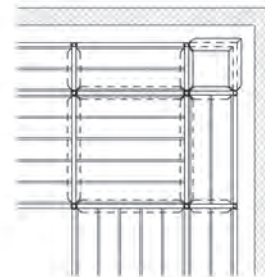

COMPONENT CAPACITIES

All Section Capacities are based on unfactored safe working loads derived in accordance with BS EN 12811-1:2003 and BS EN 1993-1-1:2005.

TURNLOK® 460 Standard		
48.3mm diameter	Effective Height	Axial Capacity
3.2mm Wall thickness	1.000m	72.5kN
S460 High Yield Steel	1.500m	44.0kN
	2.000m	27.9kN
	2.500m	18.9kN
TURNLOK® 460 Tube Transom System		
	Effective Height in Tie Patterns to TG20:13	Axial Capacity
	2.5 x1.3 x2.0m (A) 3.595m	9.8kN
	2.5 x1.3 x2.0m (B) 3.364m	11.1kN
	2.5 x1.3 x2.0m (D) 3.595m	9.8kN
	2.5 x1.3 x2.0m (E) 3.424m	10.7kN
TURNLOK® 460 OMEGA Transom System		
	Effective Height in Tie Patterns to TG20:13	Axial Capacity
	2.5 x1.3 x2.0m (A) 3.1660m	12.4kN
	2.5 x1.3 x2.0m (B) 2.938m	14.2kN
	2.5 x1.3 x2.0m (D) 3.166m	12.4kN
	2.5 x1.3 x2.0m (E) 2.967m	13.9kN
Spigots		
	Tensile Capacity @ Spigot	21.6kN
	Moment Capacity @ Spigot	1.328kNm
Base Jack		
	Axial Capacity	60kN
TURNLOK® 460 Brace		
	Axial Capacity	9.4kN
TURNLOK® 460 Ledger & Tubular Transom		
	Moment Capacity	1.78kNm
	Shear Capacity	45.5kN
	Ledger/Transom Moving Up	2.18kNm
	Ledger/Transom Moving Down	2.05kNm
	Stiffness of Joint Moving Up	74.26 kNm/Rad
	Stiffness of Joint Moving Down	69.62 kNm/Rad
TURNLOK® 460 OMEGA Transom System		
	Moment Capacity	1.70kNm
	Shear Capacity	32.02kN
	Ledger/Transom Moving Up	1.02kNm
	Ledger/Transom Moving Down	1.39kNm
	Stiffness of Joint Moving Up	86.79 kNm/Rad
	Stiffness of Joint Moving Down	97.60 kNm/Rad



The maximum loading for TURNLOK® 460 access scaffolding is **3kN/m²** (BS EN 12811 **Load Class 4**), based on 2.5m bay lengths and 1.3m transom (5 boards wide). For scaffolds with more than 1 boarded lift the maximum loading is 1 Platform @ 3kN/m² + 1 other at 1.5kN/m²

For progressive brick and block work scaffolds using 1.5m lift heights only 1 working platform is assumed at 3kN/m²

All Working Platforms are checked under each Load Case in accordance with BS EN 12811-1: 2003, table 3, for the 2.5m and 1.8m ledger sizes. For access transom arrangements with standard scaffold boards the 2.5m ledger incorporates 2 intermediate transoms at equal third intervals and the 1.8m ledger incorporates 1 intermediate transom at the centre point. In the Omega transom cases 1.3m omega transoms are used in supporting standard timber or steel battens.

Internal board arrangements follow the same principal layouts as above but the 2 and 3 internal board arrangements utilise hop up brackets fixed into the standard and the single board arrangement is a cantilever transom from the standards node point. The single board components allow the use of a live loading up to 3kN/m² as the main working platform.

The use of hop up brackets for fully loaded internal boards places a horizontal loading onto the supporting standard and hence propagates a bending moment within the member in excess of that imposed by the normal horizontal loading on the standard under the normal load cases. This increased moment serves only to decrease the permissible axial load in the standard and in extreme case leave the axial capacity so low that there is insufficient capacity for even two working lifts. To this end the live loading onto internal board hop up brackets should generally be limited to 0.75kN/m² for the 3 board hop up brackets (TG20:13 Lightly Loaded Internal Board Loading) and 1.50kN/m² in the 2 board hop up brackets although a fully loaded alternatives for both are included within the Safe Working Height tables.

The use of a loose tube brace between the Hop up bracket ledger and the main internal ledger to the standard will reduce these effects and allow increased loading to be utilised and we would refer you to the technical services department for further guidance if required.

Support Item	No. of Inside Boards	Max Bay Length (m)	UDL (kN/m ²)
Inside Board Support	1 Board	2.5m	3
Inside Board Bracket	2 Boards	2.5m	1.5
Inside Board Bracket	3 Boards	2.5m	0.75

Tubular Component Capacities

Transom

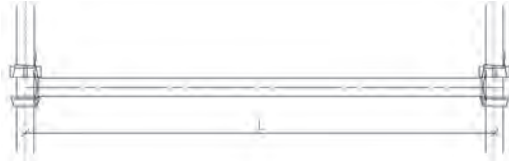

Component	Length (m)	UDL (kN)
Transom	1.3	19.4

Ledger

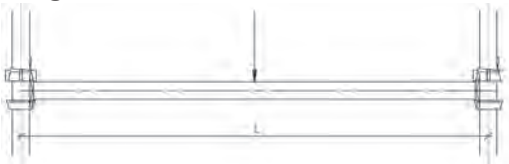

Component	Length (m)	UDL (kN)	C.P.L. (kN)	1/3 P.L. (kN)
Ledger	1.8	13.5	6.2	4.8
	2.5	8.0	4.4	2.8

Intermediate Transoms

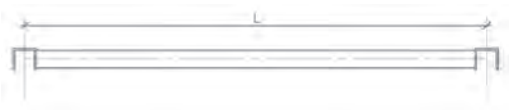

Component	Length (m)	UDL (kN)
Int. Transom	1.3	10.9
	1.8	5.60

Internal Board Support



Component	Length (m)	UDL (kN)
Int Board Support.	0.24	5.0

1 Internal Board Intermediate Transom

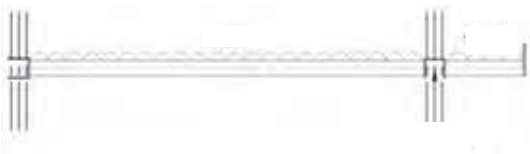

Component	Length (m)	UDL (kN)
1Int. Board Inter. Transom	1.3 + 0.24	8.3 + 3.0

Omega Component Capacities

Omega Transom

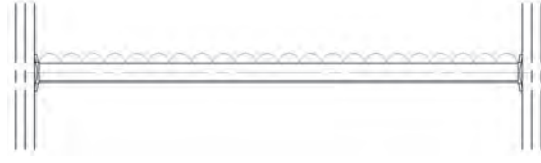

Component	Length (m)	UDL (kN)
Omega Transom	0.8 (4mm)	21.1
	1.3 (4mm)	14.3
	0.8 (3mm)	17.4
	1.3 (3mm)	11.8
	2.5 (HD)	10.6

Omega Internal Board Support



Component	Length (m)	UDL (kN)
Omega Int. Board Support	0.24	5.0



BRACING AND TYING IN

Diagonal Face Bracing:

All scaffolds require a certain amount of diagonal face bracing to eliminate any tendency of the scaffold to distort or sway.

Face bracing is required on all Turnlok® 460 scaffolding structures in one bay in every 20 metres maximum, i.e. every eighth bay, for the full height of the scaffold.

For a scaffold more than 10 metres (4 bays) long, a minimum of 2 bays should be face braced. Bracing the end bays should be avoided if possible.

Ledger and Plan Bracing

TURNLOK® 460 scaffolding structures do not generally require Ledger or plan bracing. Exceptions occur where ties cannot be placed in the correct position, where ties have to be removed for some reason, or in scaffolds which extend above the building, or in some tie arrangements.

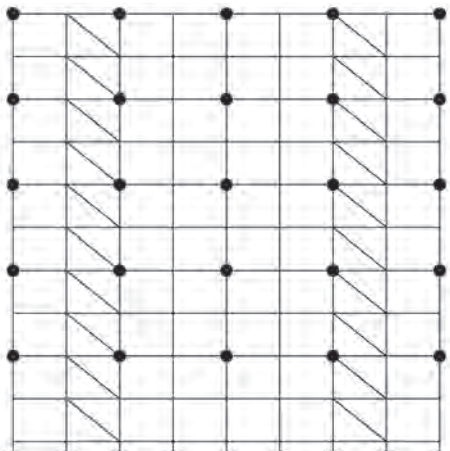

(A) Lines of Ties on Alternate Lifts

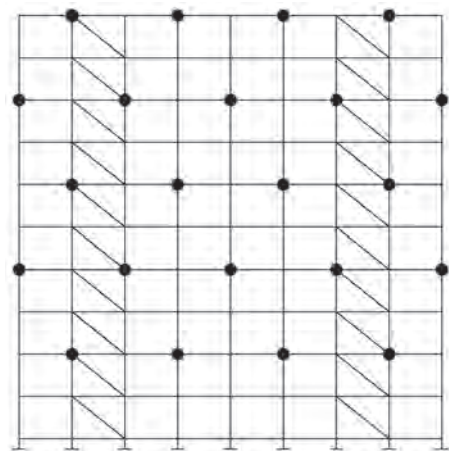

(B) Lines of Ties on Alternate Lifts

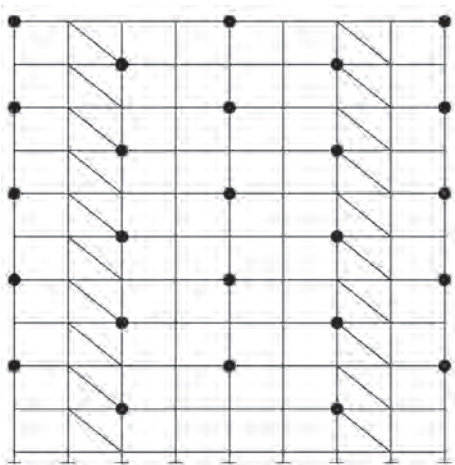

(D) Lines of Ties on Every Lift

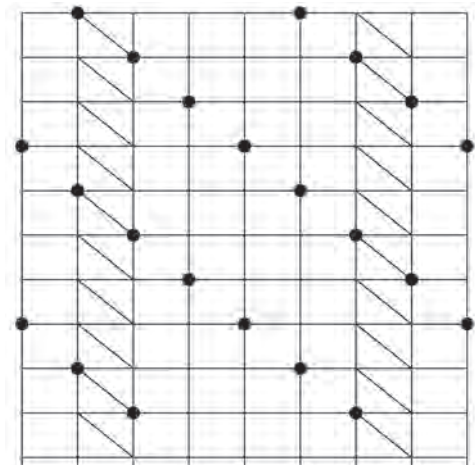

(E) Lines of Ties on Every Lift

MAXIMUM WORKING HEIGHTS

Maximum Working Heights and Tying-in Pattern Requirements

The maximum height to which a TURNLOK® 460 scaffold may be erected is dependent upon a number of factors, the most important of which are:

1. The vertical and horizontal distances between tied points on a standard.
2. The lift height.
3. Wind loading.
4. The vertical loadings in the legs due to self-weight and the working platform loading.
5. Whether or not the cantilever platforms are used.
6. Whether or not the foot ties are used.
7. The inclusion of debris netting or sheeting to the scaffold.

The parameters detailed in this manual are based on calculations and the results of testing.

IMPORTANT

The maximum height given for scaffolds in the following tables has been limited to 30 metres, incorporating a maximum of 2 working lifts. Scaffolds above 30 metres and / or incorporating more than 2 working lifts can be constructed, but special consideration should be given to their design.

General Notes

These tables should be read in conjunction with the Safe working loads Axial capacities on page 23 of this user guide which illustrates the permissible leg loads for the respective tie patterns as well as defining the tie patterns themselves. The tie patterns considered are those illustrated in TG20:13 under arrangements A, B, D and E.

The proposal within TG20:13 for providing guidance scaffold arrangements with internal lightly loaded boards with an intensity of 0.75kN/m² have also been incorporated into the tables to allow correlation between the guidance in that document as an alternative to tube and fitting access scaffolds using this loading criteria.

The tabulated values are for scaffolds having no working lifts above the last tied level. For scaffolds having working platforms above the last tied level, ledger bracing must be used in the lifts.

Given the complexity of the wind loading code, these tables have had wind loading applied with requirements of BS EN 12811-1:2003. Your temporary works engineer should be consulted for suitable wind loading design on any structures in excess of 10 metres high or in extreme positions, such as the top of a hill, exposed landscapes, sea views or in-between closely spaced buildings for further guidance.



The safe height tables and section capacities contained within the User Guide are based upon live loading from the intended use only. Additional loading may accrue on the working platforms or components as a consequence of atmospheric precipitations such as ice, snow, sand or dust. The working processes may also cause debris such as sand, grit or demolition debris to accumulate on the working platform of components which will increase the live loading above that allowed for. Where this is seen to occur or is known will occur, further guidance should be sought from your Turnlok® 460 supplier which may result in a downgrading of the Load Class for the scaffold.

All access scaffolds will impose forces upon the structure they are fixed to through their ties. An assessment should be initially made regarding the ability of the structure to sustain the loads either globally, due to its own instability, or locally as a result of defective finishes. Loadings from the ties into the supporting structure are dependent upon the live loading to the working platforms, the height of the scaffold and in the majority of cases the wind loading imposed upon the scaffold and its cladding status. For guidance with regards to the design of ties into building facades we would refer you to Section 5 of TG20:13 or to your Turnlok® 460 supplier.

Designation	S	LIGHTLY LOADED INSIDE BOARDS (TG20:13)								FULLY LOADED INSIDE BOARDS (BS EN 12811)							
		COUNTRY				TOWN				COUNTRY				TOWN			
		Ties at alternate lifts		Ties at every lift		Ties at alternate lifts		Ties at every lift		Ties at alternate lifts		Ties at every lift		Ties at alternate lifts		Ties at every lift	
		A	B	D	E	A	B	D	E	A	B	D	E	A	B	D	E
3-5-0	20	30	30	30	30	30	30	30	30	30	30	30	30	30	30	30	30
	24	22	30	22	30	24	30	24	30	22	30	22	30	24	30	24	30
	28	14	30	14	30	16	30	16	30	14	30	14	30	16	30	16	30
	32	8	30	8	30	10	30	10	30	8	30	8	30	10	30	10	30
	36	4	30	4	30	6	30	6	30	4	30	4	30	6	30	6	30
40	0	24	0	24	4	26	4	24	0	24	0	24	4	26	4	24	
3-5-1	20	30	30	30	30	30	30	30	30	28	30	28	30	28	30	28	30
	24	22	30	22	30	24	30	24	30	22	30	22	30	24	30	24	30
	28	12	30	12	30	14	30	14	30	12	30	12	30	14	30	14	30
	32	8	30	8	30	10	30	10	30	8	30	8	30	10	30	10	30
	36	4	30	4	30	6	30	6	30	4	30	4	30	6	30	6	30
40	0	24	0	22	4	24	4	24	0	24	0	22	4	24	4	24	
3-5-2	20	24	30	24	30	24	30	24	30	10	30	10	30	10	30	10	30
	24	22	30	22	30	24	30	24	30	10	30	10	30	10	30	10	30
	28	12	30	12	30	14	30	14	30	10	30	10	30	10	30	10	30
	32	6	30	6	30	10	30	10	30	6	30	6	30	8	30	8	30
	36	4	30	4	30	6	30	6	30	0	30	0	30	6	30	6	30
40	0	24	0	22	4	24	4	24	0	24	0	22	4	24	4	24	
3-5-3	20	16	30	16	30	16	30	16	30	0	16	0	16	0	16	0	16
	24	16	30	16	30	16	30	16	30	0	16	0	16	0	16	0	16
	28	12	30	12	30	14	30	14	30	0	16	0	16	0	16	0	16
	32	6	30	6	30	8	30	8	30	0	16	0	16	0	16	0	16
	36	0	30	0	30	6	30	6	30	0	16	0	16	0	16	0	16
40	0	24	0	22	4	24	4	24	0	16	0	16	0	16	0	16	
4-5-0	20	16	30	16	30	16	30	16	30	16	30	16	30	16	30	16	30
	24	16	30	16	30	16	30	16	30	16	30	16	30	16	30	16	30
	28	12	30	12	30	14	30	14	30	12	30	12	30	14	30	14	30
	32	6	30	6	30	10	30	10	30	6	30	6	30	10	30	10	30
	36	4	30	4	28	6	30	6	30	4	30	4	28	6	30	6	30
40	0	22	0	22	4	24	4	22	0	22	0	22	4	24	4	22	
4-5-1	20	16	30	16	30	16	30	16	30	4	26	4	24	4	26	4	24
	24	16	30	16	30	16	30	16	30	4	26	4	24	4	26	4	24
	28	12	30	12	30	14	30	14	30	4	26	4	24	4	26	4	24
	32	6	30	6	30	8	30	8	30	4	26	4	24	4	26	4	24
	36	4	30	4	28	6	30	6	28	4	26	4	24	4	26	4	24
40	0	22	0	22	4	24	4	22	0	22	0	22	4	24	4	22	
4-5-2	20	8	30	8	28	8	30	8	28	0	0	0	0	0	0	0	0
	24	8	30	8	28	8	30	8	28	0	0	0	0	0	0	0	0
	28	8	30	8	28	8	30	8	28	0	0	0	0	0	0	0	0
	32	6	30	6	28	8	30	8	28	0	0	0	0	0	0	0	0
	36	0	30	0	28	6	30	6	28	0	0	0	0	0	0	0	0
40	0	22	0	22	4	24	4	22	0	0	0	0	0	0	0	0	
4-5-3	20	0	20	0	20	0	20	0	20	0	0	0	0	0	0	0	0
	24	0	20	0	20	0	20	0	20	0	0	0	0	0	0	0	0
	28	0	20	0	20	0	20	0	20	0	0	0	0	0	0	0	0
	32	0	20	0	20	0	20	0	20	0	0	0	0	0	0	0	0
	36	0	20	0	20	0	20	0	20	0	0	0	0	0	0	0	0
40	0	20	0	20	0	20	0	20	0	0	0	0	0	0	0	0	

Unclad 2.5m x 1.3m Bay Omega Transom SWH (metres) Table

Designation	LIGHTLY LOADED INSIDE BOARDS (TG20:13)									FULLY LOADED INSIDE BOARDS (BS EN 12811)								
	COUNTRY					TOWN				COUNTRY				TOWN				
	Ties at alternate lifts			Ties at every lift		Ties at alternate lifts		Ties at every lift		Ties at alternate lifts		Ties at every lift		Ties at alternate lifts		Ties at every lift		
	S	A	B	D	E	A	B	D	E	A	B	D	E	A	B	D	E	
3-5-0	20	12	30	12	30	14	30	14	30	12	30	12	30	14	30	14	30	
	24	4	30	4	30	8	30	8	30	4	30	4	30	8	30	8	30	
	28	0	24	0	24	4	26	4	24	0	24	0	24	4	26	4	24	
	32	0	14	0	14	0	18	0	16	0	14	0	14	0	18	0	16	
	36	0	8	0	8	0	12	0	10	0	8	0	8	0	12	0	10	
	40	0	4	0	4	0	8	0	8	0	4	0	4	0	8	0	8	
3-5-1	20	12	30	12	30	14	30	14	30	12	30	12	30	14	30	14	30	
	24	4	30	4	30	8	30	8	30	4	30	4	30	8	30	8	30	
	28	0	24	0	24	4	26	4	24	0	24	0	24	4	26	4	24	
	32	0	14	0	14	0	16	0	16	0	14	0	14	0	16	0	16	
	36	0	8	0	8	0	10	0	10	0	8	0	8	0	10	0	10	
	40	0	4	0	4	0	8	0	8	0	4	0	4	0	8	0	8	
3-5-2	20	12	30	12	30	12	30	12	30	0	26	0	24	0	26	0	24	
	24	4	30	4	30	8	30	8	30	0	26	0	24	0	26	0	24	
	28	0	24	0	24	4	26	4	24	0	24	0	22	0	26	0	24	
	32	0	14	0	14	0	16	0	16	0	14	0	12	0	16	0	14	
	36	0	8	0	8	0	10	0	10	0	8	0	8	0	10	0	10	
	40	0	4	0	4	0	8	0	6	0	4	0	4	0	6	0	6	
3-5-3	20	0	30	0	28	0	30	0	28	0	12	0	10	0	12	0	10	
	24	0	30	0	28	0	30	0	28	0	12	0	10	0	12	0	10	
	28	0	24	0	22	0	26	0	24	0	12	0	10	0	12	0	10	
	32	0	14	0	12	0	16	0	14	0	12	0	10	0	12	0	10	
	36	0	8	0	8	0	10	0	10	0	6	0	6	0	10	0	8	
	40	0	4	0	4	0	6	0	6	0	4	0	4	0	6	0	6	
4-5-0	20	8	30	8	30	8	30	8	30	8	30	8	30	8	30	8	30	
	24	4	30	4	30	8	30	8	30	4	30	4	30	8	30	8	30	
	28	0	24	0	22	4	24	4	24	0	24	0	22	4	24	4	24	
	32	0	14	0	12	0	16	0	14	0	14	0	12	0	16	0	14	
	36	0	8	0	8	0	10	0	10	0	8	0	8	0	10	0	10	
	40	0	4	0	4	0	8	0	6	0	4	0	4	0	8	0	6	
4-5-1	20	4	30	4	30	4	30	4	30	0	20	0	16	0	20	0	16	
	24	4	30	4	30	4	30	4	30	0	20	0	16	0	20	0	16	
	28	0	22	0	22	4	24	4	22	0	20	0	16	0	20	0	16	
	32	0	14	0	12	0	16	0	14	0	14	0	12	0	16	0	14	
	36	0	8	0	8	0	10	0	10	0	8	0	8	0	10	0	10	
	40	0	4	0	4	0	8	0	6	0	4	0	4	0	8	0	6	
4-5-2	20	0	22	0	22	0	22	0	22	0	0	0	0	0	0	0	0	
	24	0	22	0	22	0	22	0	22	0	0	0	0	0	0	0	0	
	28	0	22	0	22	0	22	0	22	0	0	0	0	0	0	0	0	
	32	0	14	0	12	0	16	0	14	0	0	0	0	0	0	0	0	
	36	0	8	0	8	0	10	0	10	0	0	0	0	0	0	0	0	
	40	0	4	0	4	0	6	0	6	0	0	0	0	0	0	0	0	
4-5-3	20	0	14	0	12	0	14	0	12	0	0	0	0	0	0	0	0	
	24	0	14	0	12	0	14	0	12	0	0	0	0	0	0	0	0	
	28	0	14	0	12	0	14	0	12	0	0	0	0	0	0	0	0	
	32	0	12	0	12	0	14	0	12	0	0	0	0	0	0	0	0	
	36	0	6	0	6	0	10	0	8	0	0	0	0	0	0	0	0	
	40	0	4	0	4	0	6	0	6	0	0	0	0	0	0	0	0	

Netted 2.5m x 1.3m Bay Omega Transom SWH (metres) Table

Designation	LIGHTLY LOADED INSIDE BOARDS (TG20:13)									FULLY LOADED INSIDE BOARDS (BS EN 12811)							
	COUNTRY					TOWN				COUNTRY				TOWN			
	Ties at alternate lifts			Ties at every lift		Ties at alternate lifts		Ties at every lift		Ties at alternate lifts		Ties at every lift		Ties at alternate lifts		Ties at every lift	
	S	A	B	D	E	A	B	D	E	A	B	D	E	A	B	D	E
3-5-0	20	0	24	0	22	0	26	0	24	0	24	0	22	0	26	0	24
	24	0	12	0	10	0	14	0	12	0	12	0	10	0	14	0	12
	28	0	6	0	4	0	8	0	8	0	6	0	4	0	8	0	8
	32	0	0	0	0	0	4	0	4	0	0	0	0	0	4	0	4
	36	0	0	0	0	0	0	0	0	0	0	0	0	0	0	0	0
	40	0	0	0	0	0	0	0	0	0	0	0	0	0	0	0	0
3-5-1	20	0	24	0	22	0	24	0	24	0	24	0	22	0	24	0	24
	24	0	12	0	10	0	14	0	12	0	12	0	10	0	14	0	12
	28	0	4	0	4	0	8	0	8	0	4	0	4	0	8	0	8
	32	0	0	0	0	0	4	0	4	0	0	0	0	0	4	0	4
	36	0	0	0	0	0	0	0	0	0	0	0	0	0	0	0	0
	40	0	0	0	0	0	0	0	0	0	0	0	0	0	0	0	0
3-5-2	20	0	24	0	22	0	24	0	24	0	16	0	12	0	16	0	12
	24	0	12	0	10	0	14	0	12	0	10	0	10	0	12	0	12
	28	0	4	0	4	0	8	0	8	0	4	0	4	0	8	0	6
	32	0	0	0	0	0	4	0	4	0	0	0	0	0	4	0	4
	36	0	0	0	0	0	0	0	0	0	0	0	0	0	0	0	0
	40	0	0	0	0	0	0	0	0	0	0	0	0	0	0	0	0
3-5-3	20	0	20	0	16	0	20	0	16	0	0	0	0	0	0	0	0
	24	0	10	0	10	0	12	0	12	0	0	0	0	0	0	0	0
	28	0	4	0	4	0	8	0	6	0	0	0	0	0	0	0	0
	32	0	0	0	0	0	4	0	4	0	0	0	0	0	0	0	0
	36	0	0	0	0	0	0	0	0	0	0	0	0	0	0	0	0
	40	0	0	0	0	0	0	0	0	0	0	0	0	0	0	0	0
4-5-0	20	0	22	0	20	0	22	0	20	0	0	0	0	0	0	0	0
	24	0	10	0	10	0	12	0	12	0	10	0	10	0	12	0	12
	28	0	4	0	4	0	8	0	8	0	4	0	4	0	8	0	8
	32	0	0	0	0	0	4	0	4	0	0	0	0	0	4	0	4
	36	0	0	0	0	0	0	0	0	0	0	0	0	0	0	0	0
	40	0	0	0	0	0	0	0	0	0	0	0	0	0	0	0	0
4-5-1	20	0	22	0	20	0	22	0	20	0	8	0	6	0	8	0	6
	24	0	10	0	10	0	12	0	12	0	8	0	6	0	8	0	6
	28	0	4	0	4	0	8	0	6	0	4	0	4	0	8	0	6
	32	0	0	0	0	0	4	0	4	0	0	0	0	0	4	0	4
	36	0	0	0	0	0	0	0	0	0	0	0	0	0	0	0	0
	40	0	0	0	0	0	0	0	0	0	0	0	0	0	0	0	0
4-5-2	20	0	12	0	10	0	12	0	10	0	0	0	0	0	0	0	0
	24	0	10	0	10	0	12	0	10	0	0	0	0	0	0	0	0
	28	0	4	0	4	0	8	0	6	0	0	0	0	0	0	0	0
	32	0	0	0	0	0	4	0	4	0	0	0	0	0	0	0	0
	36	0	0	0	0	0	0	0	0	0	0	0	0	0	0	0	0
	40	0	0	0	0	0	0	0	0	0	0	0	0	0	0	0	0
4-5-3	20	0	4	0	0	0	4	0	0	0	0	0	0	0	0	0	0
	24	0	4	0	0	0	4	0	0	0	0	0	0	0	0	0	0
	28	0	4	0	0	0	4	0	0	0	0	0	0	0	0	0	0
	32	0	0	0	0	0	4	0	0	0	0	0	0	0	0	0	0
	36	0	0	0	0	0	0	0	0	0	0	0	0	0	0	0	0
	40	0	0	0	0	0	0	0	0	0	0	0	0	0	0	0	0

Sheeted 2.5m x 1.3m Bay Omega Transom SWH (metres) Table

Designation	LIGHTLY LOADED INSIDE BOARDS (TG20:13)										FULLY LOADED INSIDE BOARDS (BS EN 12811)							
	COUNTRY					TOWN					COUNTRY				TOWN			
	Ties at alternate lifts		Ties at every lift			Ties at alternate lifts		Ties at every lift			Ties at alternate lifts		Ties at every lift		Ties at alternate lifts		Ties at every lift	
	S	A	B	D	E	A	B	D	E	A	B	D	E	A	B	D	E	
3-5-0	20	30	30	30	30	30	30	30	30	30	30	30	30	30	30	30	30	
	24	30	30	30	30	30	30	30	30	30	30	30	30	30	30	30	30	
	28	22	30	22	30	24	30	24	30	22	30	22	30	24	30	24	30	
	32	12	30	12	30	14	30	14	30	12	30	12	30	14	30	14	30	
	36	8	30	8	30	10	30	10	30	8	30	8	30	10	30	10	30	
40	4	30	4	30	6	30	6	30	4	30	4	30	6	30	6	30		
3-5-1	20	30	30	30	30	30	30	30	30	30	30	30	30	30	30	30	30	
	24	30	30	30	30	30	30	30	30	30	30	30	30	30	30	30	30	
	28	22	30	22	30	24	30	24	30	22	30	22	30	24	30	24	30	
	32	12	30	12	30	14	30	14	30	12	30	12	30	14	30	14	30	
	36	8	30	8	30	10	30	10	30	8	30	8	30	10	30	10	30	
40	4	30	4	30	6	30	6	30	4	30	4	30	6	30	6	30		
3-5-2	20	30	30	30	30	30	30	30	30	30	30	30	30	30	30	30	30	
	24	30	30	30	30	30	30	30	30	30	30	30	30	30	30	30	30	
	28	22	30	22	30	24	30	24	30	22	30	22	30	24	30	24	30	
	32	12	30	12	30	14	30	14	30	12	30	12	30	14	30	14	30	
	36	8	30	8	30	10	30	10	30	6	30	6	30	10	30	10	30	
40	4	30	4	30	6	30	6	30	4	30	4	30	6	30	6	30		
3-5-3	20	30	30	30	30	30	30	30	30	24	30	24	30	24	30	24	30	
	24	30	30	30	30	30	30	30	30	24	30	24	30	24	30	24	30	
	28	22	30	22	30	24	30	24	30	20	30	20	30	22	30	22	30	
	32	12	30	12	30	14	30	14	30	10	30	10	30	12	30	12	30	
	36	6	30	6	30	10	30	10	30	6	30	6	30	8	30	8	30	
40	4	30	4	30	6	30	6	30	0	30	0	30	6	30	6	30		
4-5-0	20	30	30	30	30	30	30	30	30	30	30	30	30	30	30	30	30	
	24	30	30	30	30	30	30	30	30	30	30	30	30	30	30	30	30	
	28	22	30	22	30	22	30	22	30	22	30	22	30	22	30	22	30	
	32	12	30	12	30	14	30	14	30	12	30	12	30	14	30	14	30	
	36	8	30	8	30	10	30	10	30	8	30	8	30	10	30	10	30	
40	4	30	4	30	6	30	6	30	4	30	4	30	6	30	6	30		
4-5-1	20	30	30	30	30	30	30	30	30	30	30	30	30	30	30	30	30	
	24	30	30	30	30	30	30	30	30	30	30	30	30	30	30	30	30	
	28	22	30	22	30	22	30	22	30	22	30	22	30	22	30	22	30	
	32	12	30	12	30	14	30	14	30	12	30	12	30	14	30	14	30	
	36	6	30	6	30	10	30	10	30	6	30	6	30	10	30	10	30	
40	4	30	4	30	6	30	6	30	4	30	4	30	6	30	6	30		
4-5-2	20	30	30	30	30	30	30	30	30	12	30	12	30	12	30	12	30	
	24	30	30	30	30	30	30	30	30	12	30	12	30	12	30	12	30	
	28	22	30	22	30	22	30	22	30	12	30	12	30	12	30	12	30	
	32	12	30	12	30	14	30	14	30	10	30	10	30	12	30	12	30	
	36	6	30	6	30	10	30	10	30	6	30	6	30	8	30	8	30	
40	4	30	4	30	6	30	6	30	0	30	0	30	6	30	6	30		
4-5-3	20	28	30	28	30	28	30	28	30	0	16	0	16	0	16	0	16	
	24	28	30	28	30	28	30	28	30	0	16	0	16	0	16	0	16	
	28	20	30	20	30	22	30	22	30	0	16	0	16	0	16	0	16	
	32	12	30	12	30	14	30	14	30	0	16	0	16	0	16	0	16	
	36	6	30	6	30	8	30	8	30	0	16	0	16	0	16	0	16	
40	4	30	4	30	6	30	6	30	0	16	0	16	0	16	0	16		

Unclad 1.8m x 1.3m Bay Omega Transom SWH (metres) Table

Designation	LIGHTLY LOADED INSIDE BOARDS (TG20:13)									FULLY LOADED INSIDE BOARDS (BS EN 12811)							
	COUNTRY					TOWN				COUNTRY				TOWN			
	Ties at alternate lifts			Ties at every lift		Ties at alternate lifts		Ties at every lift		Ties at alternate lifts		Ties at every lift		Ties at alternate lifts		Ties at every lift	
	S	A	B	D	E	A	B	D	E	A	B	D	E	A	B	D	E
3-5-0	20	28	30	28	30	28	30	28	30	28	30	28	30	28	30	28	30
	24	14	30	14	30	16	30	16	30	14	30	14	30	16	30	16	30
	28	6	30	6	30	10	30	10	30	6	30	6	30	10	30	10	30
	32	0	30	0	30	6	30	6	30	0	30	0	30	6	30	6	30
	36	0	22	0	22	4	24	4	22	0	22	0	22	4	24	4	22
40	0	14	0	12	0	16	0	16	0	14	0	12	0	16	0	16	
3-5-1	20	28	30	28	30	28	30	28	30	28	30	28	30	28	30	28	30
	24	14	30	14	30	16	30	16	30	14	30	14	30	16	30	16	30
	28	6	30	6	30	10	30	10	30	6	30	6	30	10	30	10	30
	32	0	30	0	30	6	30	6	30	0	30	0	30	6	30	6	30
	36	0	22	0	22	4	24	4	22	0	22	0	22	4	24	4	22
40	0	14	0	12	0	16	0	14	0	14	0	12	0	16	0	14	
3-5-2	20	28	30	28	30	28	30	28	30	28	30	28	30	28	30	28	30
	24	14	30	14	30	16	30	16	30	12	30	12	30	16	30	16	30
	28	6	30	6	30	10	30	10	30	6	30	6	30	8	30	8	30
	32	0	30	0	30	6	30	6	30	0	30	0	30	4	30	4	30
	36	0	22	0	22	4	24	4	22	0	22	0	20	0	24	0	22
40	0	14	0	12	0	16	0	14	0	12	0	12	0	16	0	14	
3-5-3	20	28	30	28	30	28	30	28	30	16	30	16	30	16	30	16	30
	24	12	30	12	30	16	30	16	30	12	30	12	30	14	30	14	30
	28	6	30	6	30	8	30	8	30	6	30	6	30	8	30	8	30
	32	0	30	0	30	4	30	4	30	0	30	0	30	4	30	4	30
	36	0	22	0	20	0	24	0	22	0	20	0	18	0	22	0	20
40	0	12	0	12	0	14	0	14	0	12	0	12	0	14	0	14	
4-5-0	20	26	30	26	30	26	30	26	30	26	30	26	30	26	30	26	30
	24	14	30	14	30	16	30	16	30	14	30	14	30	16	30	16	30
	28	6	30	6	30	8	30	8	30	6	30	6	30	8	30	8	30
	32	0	30	0	30	6	30	6	30	0	30	0	30	6	30	6	30
	36	0	22	0	20	4	22	4	22	0	22	0	20	4	22	4	22
40	0	12	0	12	0	16	0	14	0	12	0	12	0	16	0	14	
4-5-1	20	26	30	26	30	26	30	26	30	22	30	22	30	22	30	22	30
	24	12	30	12	30	14	30	14	30	12	30	12	30	14	30	14	30
	28	6	30	6	30	8	30	8	30	6	30	6	30	8	30	8	30
	32	0	30	0	30	6	30	6	30	0	30	0	30	6	30	6	30
	36	0	20	0	20	0	22	0	22	0	20	0	20	0	22	0	22
40	0	12	0	12	0	14	0	14	0	12	0	12	0	14	0	14	
4-5-2	20	24	30	24	30	24	30	24	30	4	30	4	30	4	30	4	30
	24	12	30	12	30	14	30	14	30	4	30	4	30	4	30	4	30
	28	6	30	6	30	8	30	8	30	4	30	4	30	4	30	4	30
	32	0	30	0	30	4	30	4	30	0	30	0	30	4	30	4	30
	36	0	20	0	20	0	22	0	22	0	20	0	18	0	22	0	20
40	0	12	0	12	0	14	0	14	0	12	0	10	0	14	0	14	
4-5-3	20	16	30	16	30	16	30	16	30	0	14	0	12	0	14	0	12
	24	12	30	12	30	14	30	14	30	0	14	0	12	0	14	0	12
	28	6	30	6	30	8	30	8	30	0	14	0	12	0	14	0	12
	32	0	30	0	30	4	30	4	30	0	14	0	12	0	14	0	12
	36	0	20	0	20	0	22	0	22	0	14	0	12	0	14	0	12
40	0	12	0	12	0	14	0	14	0	10	0	10	0	12	0	12	

Netted 1.8m x 1.3m Bay Omega Transom SWH (metres) Chart



Designation	LIGHTLY LOADED INSIDE BOARDS (TG20:13)									FULLY LOADED INSIDE BOARDS (BS EN 12811)								
	COUNTRY					TOWN				COUNTRY				TOWN				
	Ties at alternate lifts			Ties at every lift		Ties at alternate lifts		Ties at every lift		Ties at alternate lifts		Ties at every lift		Ties at alternate lifts		Ties at every lift		
	S	A	B	D	E	A	B	D	E	A	B	D	E	A	B	D	E	
3-5-0	20	6	30	6	30	8	30	8	30	6	30	6	30	8	30	8	30	
	24	0	28	0	26	4	28	4	26	0	28	0	26	4	28	4	26	
	28	0	14	0	14	0	16	0	16	0	14	0	14	0	16	0	16	
	32	0	8	0	6	0	10	0	10	0	8	0	6	0	10	0	10	
	36	0	4	0	4	0	6	0	6	0	4	0	4	0	6	0	6	
40	0	0	0	0	0	4	0	4	0	0	0	0	0	4	0	4		
3-5-1	20	6	30	6	30	8	30	8	30	6	30	6	30	8	30	8	30	
	24	0	26	0	26	4	28	4	26	0	26	0	26	4	28	4	26	
	28	0	14	0	14	0	16	0	16	0	14	0	14	0	16	0	16	
	32	0	8	0	6	0	10	0	10	0	8	0	6	0	10	0	10	
	36	0	4	0	4	0	6	0	6	0	4	0	4	0	6	0	6	
40	0	0	0	0	0	4	0	4	0	0	0	0	0	4	0	4		
3-5-2	20	6	30	6	30	8	30	8	30	6	30	6	30	8	30	8	30	
	24	0	26	0	26	0	28	4	26	0	26	0	26	4	28	4	26	
	28	0	14	0	14	0	16	0	16	0	14	0	12	0	16	0	14	
	32	0	8	0	6	0	10	0	10	0	6	0	6	0	10	0	8	
	36	0	4	0	4	0	6	0	6	0	4	0	0	0	6	0	6	
40	0	0	0	0	0	4	0	4	0	0	0	0	0	4	0	4		
3-5-3	20	6	30	6	30	8	30	8	30	0	30	0	30	0	30	0	30	
	24	0	26	0	26	4	28	4	26	0	26	0	24	0	26	0	26	
	28	0	14	0	12	0	16	0	14	0	12	0	12	0	14	0	14	
	32	0	6	0	6	0	10	0	8	0	6	0	6	0	8	0	8	
	36	0	4	0	0	0	6	0	6	0	0	0	0	0	6	0	4	
40	0	0	0	0	0	4	0	4	0	0	0	0	0	4	0	4		
4-5-0	20	6	30	6	30	8	30	8	30	0	30	0	30	0	30	0	30	
	24	0	26	0	24	4	26	4	26	0	26	0	24	4	26	4	26	
	28	0	14	0	12	0	16	0	14	0	14	0	12	0	16	0	14	
	32	0	8	0	6	0	10	0	10	0	8	0	6	0	10	0	10	
	36	0	4	0	4	0	6	0	6	0	4	0	4	0	6	0	6	
40	0	0	0	0	0	4	0	4	0	0	0	0	0	4	0	4		
4-5-1	20	6	30	6	30	8	30	8	30	0	30	0	30	0	30	0	30	
	24	0	26	0	24	4	26	4	26	0	26	0	24	0	26	0	26	
	28	0	14	0	12	0	16	0	14	0	14	0	12	0	16	0	14	
	32	0	6	0	6	0	10	0	8	0	6	0	6	0	10	0	8	
	36	0	4	0	0	0	6	0	6	0	4	0	0	0	6	0	6	
40	0	0	0	0	0	4	0	4	0	0	0	0	0	4	0	4		
4-5-2	20	4	30	4	30	4	30	4	30	0	22	0	20	0	22	0	20	
	24	0	26	0	24	4	26	4	26	0	22	0	20	0	22	0	20	
	28	0	14	0	12	0	16	0	14	0	12	0	12	0	14	0	14	
	32	0	6	0	6	0	10	0	8	0	6	0	6	0	8	0	8	
	36	0	4	0	0	0	6	0	6	0	0	0	0	0	6	0	4	
40	0	0	0	0	0	4	0	4	0	0	0	0	0	4	0	4		
4-5-3	20	0	30	0	30	0	30	0	30	0	4	0	0	0	4	0	0	
	24	0	26	0	24	0	26	0	26	0	4	0	0	0	4	0	0	
	28	0	12	0	12	0	14	0	14	0	4	0	0	0	4	0	0	
	32	0	6	0	6	0	8	0	8	0	4	0	0	0	4	0	0	
	36	0	0	0	0	0	6	0	6	0	0	0	0	0	4	0	0	
40	0	0	0	0	0	4	0	4	0	0	0	0	0	0	0	0		

Sheeted 1.8m x 1.3m Bay Omega Transom SWH (metres) Chart

Designation	S	LIGHTLY LOADED INSIDE BOARDS (TG20:13)								FULLY LOADED INSIDE BOARDS (BS EN 12811)							
		COUNTRY				TOWN				COUNTRY				TOWN			
		Ties at alternate lifts		Ties at every lift		Ties at alternate lifts		Ties at every lift		Ties at alternate lifts		Ties at every lift		Ties at alternate lifts		Ties at every lift	
		A	B	D	E	A	B	D	E	A	B	D	E	A	B	D	E
3-5-0	20	16	30	16	30	16	30	16	30	16	30	16	30	16	30	16	30
	24	16	30	16	30	16	30	16	30	16	30	16	30	16	30	16	30
	28	10	30	10	30	12	30	12	30	10	30	10	30	12	30	12	30
	32	6	30	6	28	8	30	8	28	6	30	6	28	8	30	8	28
	36	0	22	0	22	4	24	4	22	0	22	0	22	4	24	4	22
40	0	16	0	16	4	18	4	18	0	16	0	16	4	18	4	18	
3-5-1	20	16	30	16	28	16	30	16	28	8	26	8	24	8	26	8	24
	24	16	30	16	28	16	30	16	28	8	26	8	24	8	26	8	24
	28	10	30	8	28	12	30	10	28	8	26	8	24	8	26	8	24
	32	4	28	4	28	8	28	8	28	4	26	4	24	8	26	8	24
	36	0	22	0	22	4	24	4	22	0	22	0	22	4	24	4	22
40	0	16	0	16	0	18	0	16	0	16	0	16	0	18	0	16	
3-5-2	20	6	24	6	20	6	24	6	20	0	8	0	6	0	8	0	6
	24	6	24	6	20	6	24	6	20	0	8	0	6	0	8	0	6
	28	6	24	6	20	6	24	6	20	0	8	0	6	0	8	0	6
	32	4	24	4	20	6	24	6	20	0	8	0	6	0	8	0	6
	36	0	22	0	20	4	22	4	20	0	8	0	6	0	8	0	6
40	0	16	0	14	0	18	0	16	0	8	0	6	0	8	0	6	
3-5-3	20	0	14	0	10	0	14	0	10	0	0	0	0	0	0	0	0
	24	0	14	0	10	0	14	0	10	0	0	0	0	0	0	0	0
	28	0	14	0	10	0	14	0	10	0	0	0	0	0	0	0	0
	32	0	14	0	10	0	14	0	10	0	0	0	0	0	0	0	0
	36	0	14	0	10	0	14	0	10	0	0	0	0	0	0	0	0
40	0	14	0	10	0	14	0	10	0	0	0	0	0	0	0	0	
4-5-0	20	4	16	4	16	4	16	4	16	4	16	4	16	4	16	4	16
	24	4	16	4	16	4	16	4	16	4	16	4	16	4	16	4	16
	28	4	16	4	16	4	16	4	16	4	16	4	16	4	16	4	16
	32	4	16	4	16	4	16	4	16	4	16	4	16	4	16	4	16
	36	0	16	0	16	4	16	4	16	0	16	0	16	4	16	4	16
40	0	14	0	14	0	16	0	16	0	14	0	14	0	16	0	16	
4-5-1	20	0	16	0	12	0	16	0	12	0	0	0	0	0	0	0	0
	24	0	16	0	12	0	16	0	12	0	0	0	0	0	0	0	0
	28	0	16	0	12	0	16	0	12	0	0	0	0	0	0	0	0
	32	0	16	0	12	0	16	0	12	0	0	0	0	0	0	0	0
	36	0	16	0	12	0	16	0	12	0	0	0	0	0	0	0	0
40	0	14	0	12	0	16	0	12	0	0	0	0	0	0	0	0	
4-5-2	20	0	4	0	0	0	4	0	0	0	0	0	0	0	0	0	0
	24	0	4	0	0	0	4	0	0	0	0	0	0	0	0	0	0
	28	0	4	0	0	0	4	0	0	0	0	0	0	0	0	0	0
	32	0	4	0	0	0	4	0	0	0	0	0	0	0	0	0	0
	36	0	4	0	0	0	4	0	0	0	0	0	0	0	0	0	0
40	0	4	0	0	0	4	0	0	0	0	0	0	0	0	0	0	
4-5-3	20	0	0	0	0	0	0	0	0	0	0	0	0	0	0	0	0
	24	0	0	0	0	0	0	0	0	0	0	0	0	0	0	0	0
	28	0	0	0	0	0	0	0	0	0	0	0	0	0	0	0	0
	32	0	0	0	0	0	0	0	0	0	0	0	0	0	0	0	0
	36	0	0	0	0	0	0	0	0	0	0	0	0	0	0	0	0
40	0	0	0	0	0	0	0	0	0	0	0	0	0	0	0	0	

Unclad 2.5m x 1.3m Bay Tube Transom SWH (metres) Chart



Designation	LIGHTLY LOADED INSIDE BOARDS (TG20:13)									FULLY LOADED INSIDE BOARDS (BS EN 12811)								
	COUNTRY					TOWN				COUNTRY				TOWN				
	Ties at alternate lifts			Ties at every lift		Ties at alternate lifts		Ties at every lift		Ties at alternate lifts		Ties at every lift		Ties at alternate lifts		Ties at every lift		
	S	A	B	D	E	A	B	D	E	A	B	D	E	A	B	D	E	
3-5-0	20	8	28	8	26	8	28	8	26	8	28	8	26	8	28	8	26	
	24	4	26	4	24	6	26	6	26	4	26	4	26	6	26	6	26	
	28	0	16	0	16	4	18	4	18	0	16	0	16	4	18	4	18	
	32	0	10	0	10	0	12	0	12	0	10	0	10	0	12	0	12	
	36	0	6	0	6	0	8	0	8	0	6	0	6	0	8	0	8	
	40	0	4	0	4	0	6	0	6	0	4	0	4	0	6	0	6	
3-5-1	20	4	26	4	24	4	26	4	24	0	20	0	16	0	20	0	16	
	24	4	26	4	24	4	26	4	24	0	20	0	16	0	20	0	16	
	28	0	16	0	16	0	18	0	18	0	16	0	16	0	18	0	16	
	32	0	10	0	10	0	12	0	12	0	10	0	10	0	12	0	12	
	36	0	6	0	6	0	8	0	8	0	6	0	6	0	8	0	8	
	40	0	0	0	0	0	6	0	6	0	0	0	0	0	6	0	6	
3-5-2	20	0	16	0	14	0	16	0	14	0	0	0	0	0	0	0	0	
	24	0	16	0	14	0	16	0	14	0	0	0	0	0	0	0	0	
	28	0	16	0	14	0	16	0	14	0	0	0	0	0	0	0	0	
	32	0	10	0	10	0	12	0	12	0	0	0	0	0	0	0	0	
	36	0	6	0	4	0	8	0	8	0	0	0	0	0	0	0	0	
	40	0	0	0	0	0	6	0	4	0	0	0	0	0	0	0	0	
3-5-3	20	0	8	0	4	0	8	0	4	0	0	0	0	0	0	0	0	
	24	0	8	0	4	0	8	0	4	0	0	0	0	0	0	0	0	
	28	0	8	0	4	0	8	0	4	0	0	0	0	0	0	0	0	
	32	0	8	0	4	0	8	0	4	0	0	0	0	0	0	0	0	
	36	0	4	0	4	0	6	0	4	0	0	0	0	0	0	0	0	
	40	0	0	0	0	0	4	0	4	0	0	0	0	0	0	0	0	
4-5-0	20	0	14	0	10	0	14	0	10	0	14	0	10	0	14	0	10	
	24	0	14	0	10	0	14	0	10	0	14	0	10	0	14	0	10	
	28	0	14	0	10	0	14	0	10	0	14	0	10	0	14	0	10	
	32	0	10	0	8	0	12	0	10	0	10	0	8	0	12	0	10	
	36	0	6	0	4	0	8	0	8	0	6	0	4	0	8	0	8	
	40	0	0	0	0	0	6	0	4	0	0	0	0	0	6	0	4	
4-5-1	20	0	10	0	8	0	10	0	8	0	0	0	0	0	0	0	0	
	24	0	10	0	8	0	10	0	8	0	0	0	0	0	0	0	0	
	28	0	10	0	8	0	10	0	8	0	0	0	0	0	0	0	0	
	32	0	8	0	8	0	10	0	8	0	0	0	0	0	0	0	0	
	36	0	4	0	4	0	8	0	8	0	0	0	0	0	0	0	0	
	40	0	0	0	0	0	4	0	4	0	0	0	0	0	0	0	0	
4-5-2	20	0	0	0	0	0	0	0	0	0	0	0	0	0	0	0	0	
	24	0	0	0	0	0	0	0	0	0	0	0	0	0	0	0	0	
	28	0	0	0	0	0	0	0	0	0	0	0	0	0	0	0	0	
	32	0	0	0	0	0	0	0	0	0	0	0	0	0	0	0	0	
	36	0	0	0	0	0	0	0	0	0	0	0	0	0	0	0	0	
	40	0	0	0	0	0	0	0	0	0	0	0	0	0	0	0	0	
4-5-3	20	0	0	0	0	0	0	0	0	0	0	0	0	0	0	0	0	
	24	0	0	0	0	0	0	0	0	0	0	0	0	0	0	0	0	
	28	0	0	0	0	0	0	0	0	0	0	0	0	0	0	0	0	
	32	0	0	0	0	0	0	0	0	0	0	0	0	0	0	0	0	
	36	0	0	0	0	0	0	0	0	0	0	0	0	0	0	0	0	
	40	0	0	0	0	0	0	0	0	0	0	0	0	0	0	0	0	

Netted 2.5m x 1.3m Bay Tube Transom SWH (metres) Chart

Designation	LIGHTLY LOADED INSIDE BOARDS (TG20:13)									FULLY LOADED INSIDE BOARDS (BS EN 12811)							
	COUNTRY					TOWN				COUNTRY				TOWN			
	Ties at alternate lifts			Ties at every lift		Ties at alternate lifts		Ties at every lift		Ties at alternate lifts		Ties at every lift		Ties at alternate lifts		Ties at every lift	
	S	A	B	D	E	A	B	D	E	A	B	D	E	A	B	D	E
3-5-0	20	0	16	0	16	0	18	0	16	0	16	0	16	0	18	0	16
	24	0	8	0	8	0	10	0	10	0	8	0	8	0	10	0	10
	28	0	4	0	4	0	6	0	6	0	4	0	4	0	6	0	6
	32	0	0	0	0	0	4	0	4	0	0	0	0	0	4	0	4
	36	0	0	0	0	0	0	0	0	0	0	0	0	0	0	0	0
	40	0	0	0	0	0	0	0	0	0	0	0	0	0	0	0	0
3-5-1	20	0	16	0	14	0	16	0	14	0	10	0	8	0	10	0	8
	24	0	8	0	8	0	10	0	10	0	8	0	8	0	10	0	8
	28	0	4	0	4	0	6	0	6	0	4	0	4	0	6	0	6
	32	0	0	0	0	0	4	0	4	0	0	0	0	0	4	0	4
	36	0	0	0	0	0	0	0	0	0	0	0	0	0	0	0	0
	40	0	0	0	0	0	0	0	0	0	0	0	0	0	0	0	0
3-5-2	20	0	6	0	4	0	6	0	4	0	0	0	0	0	0	0	0
	24	0	6	0	4	0	6	0	4	0	0	0	0	0	0	0	0
	28	0	0	0	0	0	6	0	4	0	0	0	0	0	0	0	0
	32	0	0	0	0	0	0	0	0	0	0	0	0	0	0	0	0
	36	0	0	0	0	0	0	0	0	0	0	0	0	0	0	0	0
	40	0	0	0	0	0	0	0	0	0	0	0	0	0	0	0	0
3-5-3	20	0	0	0	0	0	0	0	0	0	0	0	0	0	0	0	0
	24	0	0	0	0	0	0	0	0	0	0	0	0	0	0	0	0
	28	0	0	0	0	0	0	0	0	0	0	0	0	0	0	0	0
	32	0	0	0	0	0	0	0	0	0	0	0	0	0	0	0	0
	36	0	0	0	0	0	0	0	0	0	0	0	0	0	0	0	0
	40	0	0	0	0	0	0	0	0	0	0	0	0	0	0	0	0
4-5-0	20	0	4	0	0	0	4	0	0	0	0	0	0	0	0	0	0
	24	0	4	0	0	0	4	0	0	0	4	0	0	0	4	0	0
	28	0	0	0	0	0	4	0	0	0	0	0	0	0	4	0	0
	32	0	0	0	0	0	0	0	0	0	0	0	0	0	0	0	0
	36	0	0	0	0	0	0	0	0	0	0	0	0	0	0	0	0
	40	0	0	0	0	0	0	0	0	0	0	0	0	0	0	0	0
4-5-1	20	0	0	0	0	0	0	0	0	0	0	0	0	0	0	0	0
	24	0	0	0	0	0	0	0	0	0	0	0	0	0	0	0	0
	28	0	0	0	0	0	0	0	0	0	0	0	0	0	0	0	0
	32	0	0	0	0	0	0	0	0	0	0	0	0	0	0	0	0
	36	0	0	0	0	0	0	0	0	0	0	0	0	0	0	0	0
	40	0	0	0	0	0	0	0	0	0	0	0	0	0	0	0	0
4-5-2	20	0	0	0	0	0	0	0	0	0	0	0	0	0	0	0	0
	24	0	0	0	0	0	0	0	0	0	0	0	0	0	0	0	0
	28	0	0	0	0	0	0	0	0	0	0	0	0	0	0	0	0
	32	0	0	0	0	0	0	0	0	0	0	0	0	0	0	0	0
	36	0	0	0	0	0	0	0	0	0	0	0	0	0	0	0	0
	40	0	0	0	0	0	0	0	0	0	0	0	0	0	0	0	0
4-5-3	20	0	0	0	0	0	0	0	0	0	0	0	0	0	0	0	0
	24	0	0	0	0	0	0	0	0	0	0	0	0	0	0	0	0
	28	0	0	0	0	0	0	0	0	0	0	0	0	0	0	0	0
	32	0	0	0	0	0	0	0	0	0	0	0	0	0	0	0	0
	36	0	0	0	0	0	0	0	0	0	0	0	0	0	0	0	0
	40	0	0	0	0	0	0	0	0	0	0	0	0	0	0	0	0

Sheeted 2.5m x 1.3m Bay Tube Transom SWH (metres) Chart

Designation	LIGHTLY LOADED INSIDE BOARDS (TG20:13)										FULLY LOADED INSIDE BOARDS (BS EN 12811)							
	COUNTRY					TOWN					COUNTRY				TOWN			
	Ties at alternate lifts		Ties at every lift			Ties at alternate lifts		Ties at every lift			Ties at alternate lifts		Ties at every lift		Ties at alternate lifts		Ties at every lift	
	S	A	B	D	E	A	B	D	E	A	B	D	E	A	B	D	E	
3-5-0	20	30	30	30	30	30	30	30	30	30	30	30	30	30	30	30	30	30
	24	26	30	26	30	28	30	28	30	26	30	26	30	28	30	28	30	30
	28	18	30	18	30	18	30	18	30	18	30	18	30	18	30	18	30	30
	32	10	30	10	30	12	30	12	30	10	30	10	30	12	30	12	30	30
	36	6	30	6	30	8	30	8	30	6	30	6	30	8	30	8	30	30
40	4	30	4	30	6	30	6	30	4	30	4	30	6	30	6	30	30	
3-5-1	20	30	30	30	30	30	30	30	30	30	30	30	30	30	30	30	30	30
	24	26	30	26	30	26	30	26	30	26	30	26	30	26	30	26	30	30
	28	16	30	16	30	18	30	18	30	16	30	16	30	18	30	18	30	30
	32	10	30	10	30	12	30	12	30	10	30	10	30	12	30	12	30	30
	36	6	30	6	30	8	30	8	30	6	30	6	30	8	30	8	30	30
40	0	28	0	30	6	30	6	30	0	28	0	30	6	30	6	30	30	
3-5-2	20	30	30	30	30	30	30	30	30	16	30	16	30	16	30	16	30	30
	24	26	30	26	30	26	30	26	30	16	30	16	30	16	30	16	30	30
	28	16	30	16	30	18	30	18	30	16	30	16	30	16	30	16	30	30
	32	10	30	10	30	12	30	12	30	10	30	10	30	12	30	12	30	30
	36	6	30	6	30	8	30	8	30	4	30	4	30	8	30	8	30	30
40	0	28	0	30	6	30	6	30	0	28	0	30	4	30	4	30	30	
3-5-3	20	24	30	24	30	24	30	24	30	6	26	6	22	6	26	6	22	22
	24	24	30	24	30	24	30	24	30	6	26	6	22	6	26	6	22	22
	28	16	30	16	30	18	30	18	30	6	26	6	22	6	26	6	22	22
	32	10	30	10	30	12	30	12	30	6	26	6	22	6	26	6	22	22
	36	6	30	6	30	8	30	8	30	4	26	4	22	6	26	6	22	22
40	0	28	0	30	6	28	6	30	0	26	0	22	4	26	4	22	22	
4-5-0	20	22	30	22	30	22	30	22	30	22	30	22	30	22	30	22	30	30
	24	22	30	22	30	22	30	22	30	22	30	22	30	22	30	22	30	30
	28	16	30	16	30	18	30	18	30	16	30	16	30	18	30	18	30	30
	32	10	30	10	30	12	30	12	30	10	30	10	30	12	30	12	30	30
	36	4	30	4	30	8	30	8	30	4	30	4	30	8	30	8	30	30
40	0	28	0	30	4	28	4	30	0	28	0	30	4	28	4	30	30	
4-5-1	20	22	30	22	30	22	30	22	30	12	30	12	26	12	30	12	26	26
	24	22	30	22	30	22	30	22	30	12	30	12	26	12	30	12	26	26
	28	16	30	16	30	18	30	18	30	12	30	12	26	12	30	12	26	26
	32	8	30	8	30	12	30	12	30	8	30	8	26	12	30	12	26	26
	36	4	30	4	30	8	30	8	30	4	30	4	26	8	30	8	26	26
40	0	28	0	30	4	28	4	30	0	28	0	26	4	28	4	26	26	
4-5-2	20	16	30	16	30	16	30	16	30	0	12	0	8	0	12	0	8	8
	24	16	30	16	30	16	30	16	30	0	12	0	8	0	12	0	8	8
	28	16	30	16	30	16	30	16	30	0	12	0	8	0	12	0	8	8
	32	8	30	8	30	12	30	12	30	0	12	0	8	0	12	0	8	8
	36	4	30	4	30	8	30	8	30	0	12	0	8	0	12	0	8	8
40	0	28	0	30	4	28	4	30	0	12	0	8	0	12	0	8	8	
4-5-3	20	10	28	10	26	10	28	10	26	0	0	0	0	0	0	0	0	0
	24	10	28	10	26	10	28	10	26	0	0	0	0	0	0	0	0	0
	28	10	28	10	26	10	28	10	26	0	0	0	0	0	0	0	0	0
	32	8	28	8	26	10	28	10	26	0	0	0	0	0	0	0	0	0
	36	4	28	4	26	8	28	8	26	0	0	0	0	0	0	0	0	0
40	0	28	0	26	4	28	4	26	0	0	0	0	0	0	0	0	0	

Unclad 1.8m x 1.3m Bay Tube Transom SWH (metres) Chart

Designation	S	LIGHTLY LOADED INSIDE BOARDS (TG20:13)								FULLY LOADED INSIDE BOARDS (BS EN 12811)							
		COUNTRY				TOWN				COUNTRY				TOWN			
		Ties at alternate lifts		Ties at every lift		Ties at alternate lifts		Ties at every lift		Ties at alternate lifts		Ties at every lift		Ties at alternate lifts		Ties at every lift	
		A	B	D	E	A	B	D	E	A	B	D	E	A	B	D	E
3-5-0	20	22	30	22	30	22	30	22	30	22	30	22	30	22	30	22	30
	24	10	30	10	30	12	30	12	30	10	30	10	30	12	30	12	30
	28	6	30	6	30	8	30	8	30	6	30	6	30	8	30	8	30
	32	0	26	0	26	4	26	4	26	0	26	0	26	4	26	4	26
	36	0	18	0	18	0	20	0	20	0	18	0	18	0	20	0	20
40	0	12	0	12	0	14	0	12	0	12	0	12	0	14	0	12	
3-5-1	20	20	30	20	30	22	30	22	30	20	30	20	30	22	30	22	30
	24	10	30	10	30	12	30	12	30	10	30	10	30	12	30	12	30
	28	4	30	4	30	8	30	8	30	4	30	4	30	8	30	8	30
	32	0	26	0	24	4	26	4	26	0	26	0	24	4	26	4	26
	36	0	18	0	16	0	20	0	18	0	18	0	16	0	20	0	18
40	0	12	0	10	0	12	0	12	0	12	0	10	0	12	0	12	
3-5-2	20	20	30	20	30	22	30	22	30	12	30	12	30	12	30	12	30
	24	10	30	10	30	12	30	12	30	10	30	10	30	12	30	12	30
	28	4	30	4	30	8	30	8	30	4	30	4	30	8	30	8	30
	32	0	26	0	24	4	26	4	26	0	26	0	24	4	26	4	26
	36	0	18	0	16	0	20	0	18	0	18	0	16	0	20	0	18
40	0	12	0	10	0	12	0	12	0	10	0	10	0	12	0	12	
3-5-3	20	16	30	16	30	16	30	16	30	0	22	0	16	0	22	0	16
	24	10	30	10	30	12	30	12	30	0	22	0	16	0	22	0	16
	28	4	30	4	30	8	30	8	30	0	22	0	16	0	22	0	16
	32	0	26	0	24	4	26	4	26	0	22	0	16	0	22	0	16
	36	0	18	0	16	0	20	0	18	0	16	0	16	0	18	0	16
40	0	10	0	10	0	12	0	12	0	10	0	10	0	12	0	12	
4-5-0	20	16	30	16	30	16	30	16	30	16	30	16	30	16	30	16	30
	24	10	30	10	30	12	30	12	30	10	30	10	30	12	30	12	30
	28	4	30	4	30	8	30	8	30	4	30	4	30	8	30	8	30
	32	0	24	0	24	4	26	4	24	0	24	0	24	4	26	4	24
	36	0	16	0	16	0	18	0	18	0	16	0	16	0	18	0	18
40	0	10	0	10	0	12	0	12	0	10	0	10	0	12	0	12	
4-5-1	20	14	30	14	30	14	30	14	30	4	26	4	24	4	26	4	24
	24	10	30	10	30	12	30	12	30	4	26	4	24	4	26	4	24
	28	4	30	4	30	6	30	6	30	4	26	4	24	4	26	4	24
	32	0	24	0	24	4	26	4	24	0	24	0	24	4	26	4	24
	36	0	16	0	16	0	18	0	18	0	16	0	16	0	18	0	18
40	0	10	0	10	0	12	0	12	0	10	0	10	0	12	0	12	
4-5-2	20	8	30	8	28	8	30	8	28	0	8	0	4	0	8	0	4
	24	8	30	8	28	8	30	8	28	0	8	0	4	0	8	0	4
	28	4	30	4	28	6	30	6	28	0	8	0	4	0	8	0	4
	32	0	24	0	24	4	26	4	24	0	8	0	4	0	8	0	4
	36	0	16	0	16	0	18	0	18	0	8	0	4	0	8	0	4
40	0	10	0	10	0	12	0	12	0	8	0	4	0	8	0	4	
4-5-3	20	0	26	0	22	0	26	0	22	0	0	0	0	0	0	0	0
	24	0	26	0	22	0	26	0	22	0	0	0	0	0	0	0	0
	28	0	26	0	22	0	26	0	22	0	0	0	0	0	0	0	0
	32	0	24	0	22	0	24	0	22	0	0	0	0	0	0	0	0
	36	0	16	0	16	0	18	0	18	0	0	0	0	0	0	0	0
40	0	10	0	10	0	12	0	12	0	0	0	0	0	0	0	0	

Netted 1.8m x 1.3m Bay Tube Transom SWH (metres) Chart



Designation	LIGHTLY LOADED INSIDE BOARDS (TG20:13)									FULLY LOADED INSIDE BOARDS (BS EN 12811)								
	COUNTRY					TOWN				COUNTRY				TOWN				
	Ties at alternate lifts			Ties at every lift		Ties at alternate lifts		Ties at every lift		Ties at alternate lifts		Ties at every lift		Ties at alternate lifts		Ties at every lift		
	S	A	B	D	E	A	B	D	E	A	B	D	E	A	B	D	E	
3-5-0	20	4	30	4	30	8	30	8	30	4	30	4	30	8	30	8	30	
	24	0	22	0	22	4	24	4	22	0	22	0	22	4	24	4	22	
	28	0	12	0	12	0	14	0	14	0	12	0	12	0	14	0	14	
	32	0	6	0	6	0	8	0	8	0	6	0	6	0	8	0	8	
	36	0	4	0	0	0	6	0	6	0	4	0	0	0	6	0	6	
	40	0	0	0	0	0	4	0	4	0	0	0	0	0	4	0	4	
3-5-1	20	4	30	4	30	6	30	6	30	4	30	4	30	4	30	4	30	
	24	0	22	0	20	4	24	4	22	0	22	0	20	4	24	4	22	
	28	0	12	0	12	0	14	0	12	0	12	0	12	0	14	0	12	
	32	0	6	0	6	0	8	0	8	0	6	0	6	0	8	0	8	
	36	0	0	0	0	0	6	0	6	0	0	0	0	0	6	0	6	
	40	0	0	0	0	0	4	0	4	0	0	0	0	0	4	0	4	
3-5-2	20	4	30	4	30	4	30	4	30	0	26	0	22	0	26	0	22	
	24	0	22	0	20	0	22	4	22	0	22	0	20	0	22	0	22	
	28	0	12	0	10	0	14	0	12	0	12	0	10	0	14	0	12	
	32	0	6	0	6	0	8	0	8	0	6	0	6	0	8	0	8	
	36	0	0	0	0	0	6	0	6	0	0	0	0	0	6	0	4	
	40	0	0	0	0	0	4	0	4	0	0	0	0	0	4	0	4	
3-5-3	20	0	30	0	28	0	30	0	28	0	14	0	10	0	14	0	10	
	24	0	22	0	20	0	22	0	22	0	14	0	10	0	14	0	10	
	28	0	12	0	10	0	14	0	12	0	10	0	10	0	12	0	10	
	32	0	6	0	6	0	8	0	8	0	6	0	4	0	8	0	8	
	36	0	0	0	0	0	6	0	6	0	0	0	0	0	4	0	4	
	40	0	0	0	0	0	4	0	4	0	0	0	0	0	4	0	0	
4-5-0	20	0	28	0	26	0	28	0	26	0	14	0	10	0	14	0	10	
	24	0	20	0	20	0	22	0	20	0	20	0	20	0	22	0	20	
	28	0	10	0	10	0	12	0	12	0	10	0	10	0	12	0	12	
	32	0	6	0	6	0	8	0	8	0	6	0	6	0	8	0	8	
	36	0	0	0	0	0	6	0	4	0	0	0	0	0	6	0	4	
	40	0	0	0	0	0	4	0	4	0	0	0	0	0	4	0	4	
4-5-1	20	0	28	0	24	0	28	0	24	0	16	0	14	0	16	0	14	
	24	0	20	0	20	0	22	0	20	0	16	0	14	0	16	0	14	
	28	0	10	0	10	0	12	0	12	0	10	0	10	0	12	0	12	
	32	0	6	0	6	0	8	0	8	0	6	0	6	0	8	0	8	
	36	0	0	0	0	0	6	0	4	0	0	0	0	0	6	0	4	
	40	0	0	0	0	0	4	0	4	0	0	0	0	0	4	0	4	
4-5-2	20	0	22	0	20	0	22	0	20	0	0	0	0	0	0	0	0	
	24	0	20	0	20	0	22	0	20	0	0	0	0	0	0	0	0	
	28	0	10	0	10	0	12	0	12	0	0	0	0	0	0	0	0	
	32	0	6	0	6	0	8	0	8	0	0	0	0	0	0	0	0	
	36	0	0	0	0	0	6	0	4	0	0	0	0	0	0	0	0	
	40	0	0	0	0	0	4	0	4	0	0	0	0	0	0	0	0	
4-5-3	20	0	16	0	14	0	16	0	14	0	0	0	0	0	0	0	0	
	24	0	16	0	14	0	16	0	14	0	0	0	0	0	0	0	0	
	28	0	10	0	10	0	12	0	12	0	0	0	0	0	0	0	0	
	32	0	6	0	4	0	8	0	8	0	0	0	0	0	0	0	0	
	36	0	0	0	0	0	6	0	4	0	0	0	0	0	0	0	0	
	40	0	0	0	0	0	4	0	0	0	0	0	0	0	0	0	0	

Sheeted 1.8m x 1.3m Bay Tube Transom SWH (metres) Chart

This User Guide utilises wind loading in the preparation of its safe working height tables for access scaffold. The above tables are limited to “S” values of 24 but further tables are available from your Turnlok® 460 supplier for values between 20 and 40. Where localised conditions result in “S” values outside of these parameters the wind velocity pressures will either be lower than or exceed those utilised within the calculations from which the tables are derived. Scaffolds located to the edges of cliffs or escarpments, in coastal locations or close to tall structures surrounded by other tall structures which may cause funnelling of the wind pressure are all susceptible to significant increases in wind pressure due to local effects. In these instances it is recommended that advice is sought from your Turnlok® 460 supplier.

Equipment Required for Tying In

Additional components outside the systems standard component set may be required to enable use in accordance with this User Guide. These will normally constitute loose tubes to EN39 and fittings to EN74 which can be supplied by your Turnlok® 460 supplier.

Foundations and Ground Condition

The foundations for a scaffold should be adequate to carry and disperse the load imposed both locally at each standard and, in general, to carry the whole weight of the scaffold. The responsibility for the adequacy of the foundations should be established and approved prior to erection. The client for the scaffold and / or the contractor may need to be consulted. The foundation for a scaffold should be maintained in an adequate condition during the life of the scaffold. Regular inspection procedures must be provided and use suspended if there is found to be any loss of support.



CIRCULAR ACCESS

By virtue of the unique 360° cup, TURNLOK® 460 is ideally suited to form circular or curved structures. By using varying sizes of Ledger, both internal and external radii can be achieved.

Curved structures can be created by using a mix of rectangular (square) bays and trapezium bays. Intermediate trapezium bays should be made with short Ledgers to ensure boards are not spanned beyond their support limit. Boards should oversail by at least 150mm. In rectangular bays Intermediate Transoms can be used to support boards every 1.2m. For Omega circular structures, rectangular bays can consist of standard size battens, 1.3m wide. In the curved position, it will not be possible to fit ledgers unless they are at 90° to each other. In this case, the outer Ledger can be positioned as double handrails. An internal Ledger can be lowered by 0.5m, as it will not be supporting an Intermediate Transom. Care should be taken to ensure that scaffold boards are cut appropriate to the curve and no traps are encountered. Ties should always be used and positioned within 300mm of a secure node point. Any non-standard structure should always be designed by a competent person.

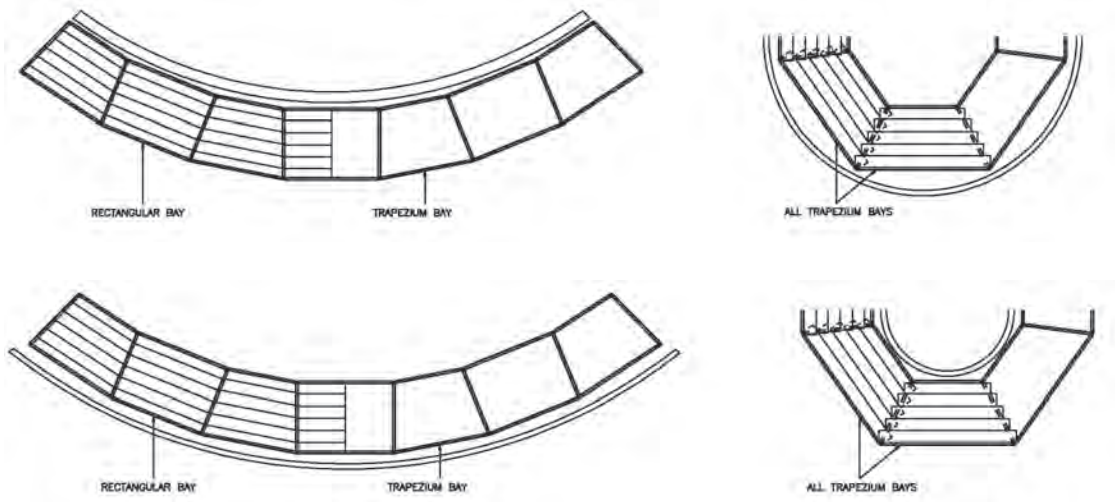

Internal and External Curves using Rectangular and Trapezium Bays.

For Trapezium bays and special structures use the full range of alternative ledger lengths.

ACCESS TOWERS

Towers for access to other structures or as working platforms can be easily achieved with Turnlok® 460 system scaffolding components. Towers can incorporate either a ladder or staircase access.

Towers can be static or mobile, free standing or tied in depending upon the application or height.

Braces

All faces of the tower must be fitted with vertical braces over its full height. Plan braces must be fitted to the base lift, the working lift and every second lift between these two. Loose EN39 tubes and EN74 fittings should be used to form the plan bracing. Scaffold tubes should be fitted to the standards using right angled couplers within 300mm of the node point but this may restrict headroom to any second boarded lifts.

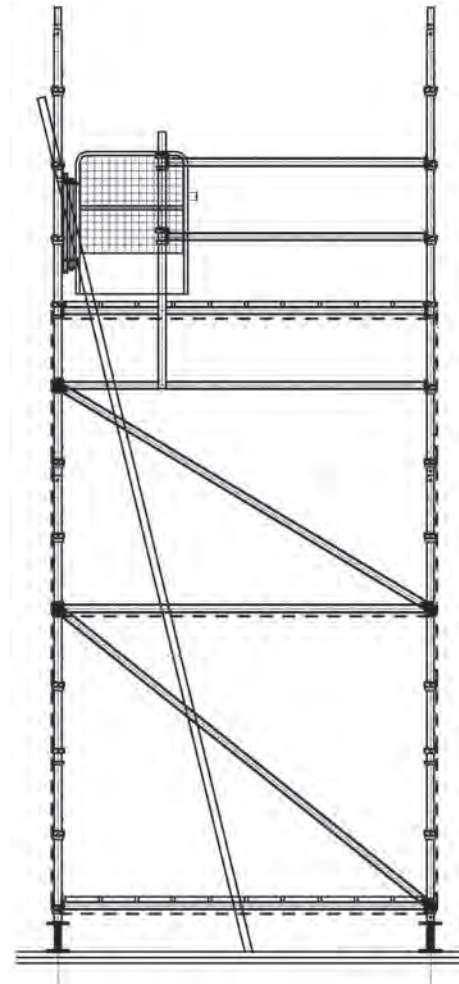

Static Access Tower

Base Dimension (m)	Max No. Working Lifts	UDL (kN/m ²)	Safe Height Static Indoor	Safe Height Static Outdoor	Safe Height Mobile Indoor	Safe Height Mobile Outdoor
1.3 x 1.3	1.5	3.00	5.2	4.55	4.55	3.9
1.3 x 1.8	1.5	3.00	5.2	4.55	4.55	3.9
1.3 x 2.5	1.5	3.00	5.2	4.55	4.55	3.9
1.8 x 1.8	1.5	2.00	7.2	6.3	6.3	5.4
1.8 x 2.5	1.5	1.50	7.2	6.3	6.3	5.4
2.5 x 2.5	1.5	0.75	10	8.75	8.75	7.5



LOADING PLATFORMS

TURNLOK® 460 can be used to create loading towers for the purpose of distribution of pallets of materials to the working level by site forklift or loader. The tower is built progressively with the working lift to match bricklayer's progress.

Made from a square 2.5m bay the tower can be free standing up to 6m or tied or integrally built to the main structure. Two additional components are required to provide the correct strength to the loading platform, Heavy Duty 2.5m Board Bearers and Knee Brace, which supports the loaded ledgers. Eight Board Bearers are required; Plan bracing will be required at the foot tie and under the loaded platform using regular tube and fittings. Towers should be face braced on each lift on each side using Swivel Face Braces appropriate to the lift height.

Board Bearers

8 evenly spaced board bearers are used under the boarded or battened platform to be supported by a 2.5m ledger reinforced with Knee Braces or the loading bay transom.

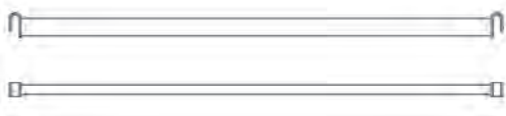

Code	Length (m)	Weight (kg)
VRS86	2.500	17.3

Loading Bay Knee Brace

Used to reinforce the ledger supporting the board bearers. They are used in pairs to opposite faces of the loading bay and are supported on a ledger lift placed 1.5m below the loading platform level next to the node.



Code	Length (m)	Weight (kg)
VRS104	1.86	8.23

Loading Bay Beam

An alternative to the ledger and knee brace arrangement, it fixes into the standards and two cups at the platform level. This allows the lower level to be used as a working platform or another loading bay. This arrangement will require an assessment of the capacity of the tower standards with potentially a reduction in the loadings advised on the following page.

The load bay beam has been independently tested and found to have a minimum safe working load of 15.6 kN/m.

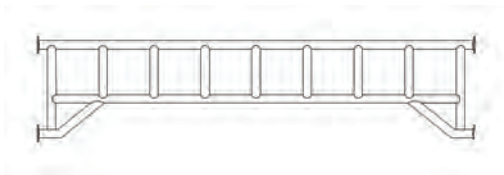

Code	Length (m)	Weight (kg)
VRS85	2.500	30.0



Permissible Uniformly Distributed Loads

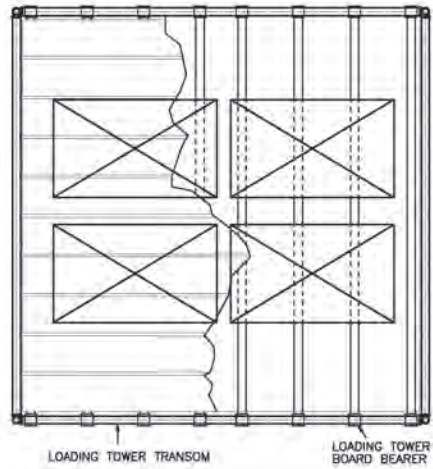

Four No. 10kN (1 Ton) Pallets

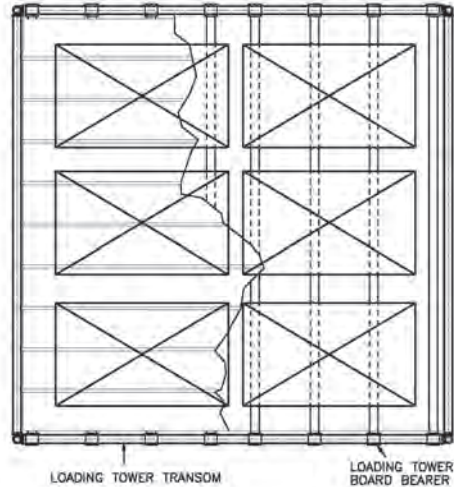

Six No. 0.85kN (0.85 Ton) Pallets

Decking is made up of regular 38mm scaffold boards cut to size 2.43m and supported at no more than 345mm centres using eight loading tower Board Bearers. A Turnlok® 460 Erection Guide is available on our web site or via your local branch.

When erecting loading towers, consideration needs to be given to the use of harnesses and if required collective protection methods as noted in NASC guidance note SG4:10. Temporary platforms will be required at each lift level to safely erect these towers.

Contact your Turnlok® 460 supplier for a wide range of Loading Bay Gates to suit all Turnlok® 460 applications.

STAIR TOWERS

Staircases

Turnlok® 460 system scaffolding can be used to provide a safe, stable site staircase enabling personnel to gain access to the working level swiftly and efficiently. Independently to other scaffolds or integral to Turnlok® 460 façade scaffolds, towers can be erected with full access landings, double handrails and non-slip stair units in either steel or aluminium.

The use of Turnlok® 460 staircases on site improves safety, replacing ladders and allows multiple numbers of personnel to climb safely to their work place at one time. The most popular are a four-leg tower with a footprint of 1.8m by 3.0m and an eight-leg tower with a footprint of 1.8m by 4.4m providing a full width landing at each level.

Stair units come in 1.5m and 2.0m units. 1.5m can be used where access is required to a base lift of 1.5m. Further lifts will rise at 2m increments.

Erection of staircases does not follow the normal sequence of access scaffolding and care must be taken in their erection. It will be necessary to create temporary working platforms and additional hand railing to efficiently and safely erect staircase towers. Erectors should work within the guidance of SG4:05A and should consider where appropriate the use of collective protection systems.

Generally, toe boards are not required on staircase landing platforms, as they do not constitute a working platform. TG20:13 states that “toe boards can be dispensed with” however, toe boards may be required as a result of a local risk assessment.

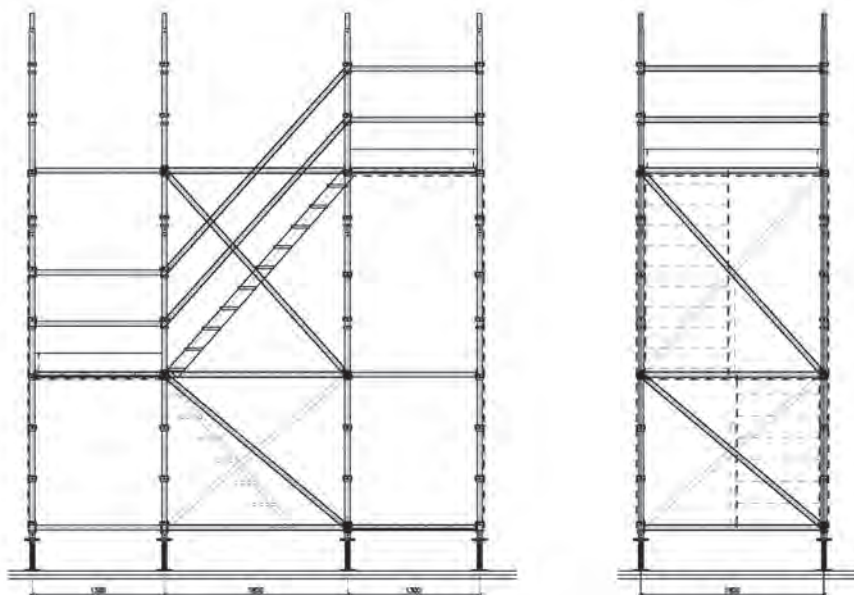



BIRDCAGE ACCESS SCAFFOLDS

Birdcage scaffolds are used to provide access to large surface areas such as ceilings, light-wells and atriums.

They normally have the top lift boarded but can integrate access scaffolds to the sides for access to the wall surfaces as well if required. A foot tie is required on all birdcage scaffolds although 1 bay may be omitted to allow access through the scaffold as long as a braced bay occurs at least once either side of the free bay. Sheeting and debris netting should not be used on any birdcage without advice being sought from your Turnlok® 460 supplier or a competent temporary works engineer.

Bracing

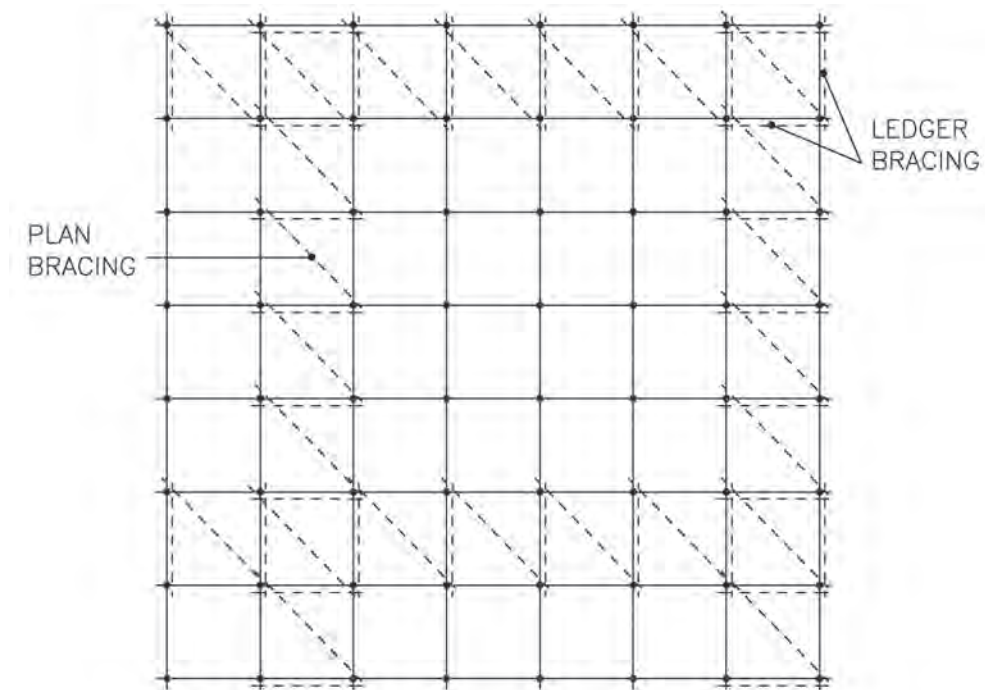

PLAN ON BIRDCAGE SCAFFOLD INDICATING BRACING

It is necessary to integrate vertical ledger bracing every 5th bay throughout the birdcage in both directions.

Within the birdcage the 4 available connection points in the standard cups will be taken by the ledgers and transoms. It will therefore be acceptable to use EN39 tubes and EN74 fittings to form the ledger bracing with right-angle couplers (the preferred option) or swivel couplers to the standards so that there will be no clash between them and the decking and toeboards. All bracing connections should be placed within 30mm of the node point.

Plan Bracing is also required every 5th bay horizontally to the top, bottom and every other lift between. Plan bracing should be fixed between standards using EN39 tubes and EN74 fittings as the vertical bracing. It should be also placed within 300mm of the node point but this may cause a restriction with regards any headroom requirements below if there are multiple boarded lifts required.



BIRDCAGE ELEVATION

Safe Heights

The maximum height of a birdcage scaffold should not exceed the smallest base dimension if free-standing. The birdcage should be butted up to the walls and other structures or otherwise tied in where possible. Where birdcages in excess or those noted in the table below are required advice should be sought from your Turnlok® 460 supplier or a competent temporary works engineer.

Grid Dimension (m)	Max No. Working Platforms	UDL (kN/m ²)
1.3 x 1.3	1	3.00
1.3 x 1.8	1	3.00
1.3 x 2.5	1	3.00
1.8 x 1.8	1	2.00
1.8 x 2.5	1	1.50
2.5 x 2.5	1	0.75



RESCUE PLAN

TURNLOK[®] 460 is a fast and simple system which when erected by suitably trained and skilled operatives improves levels of safety over traditional methods. Automatic positioning of all components including handrails without the need for leveling ensures safety whilst erecting. The system with handleable components is easily erected safely and efficiently.

However, erectors need to be mindful of the risks and plan to work as safely as possible. In accordance with the Fall From Heights Regulations 2005 (as amended), every attempt should be made to “mitigate the risk involved by prevention of falls by using work equipment or other measures to prevent falls. Where they cannot avoid working at height and where they cannot eliminate the risk of a fall, use work equipment or other measures to minimize the distance and consequences of a fall should one occur”.

Advanced Guardrail systems, Hop-Ups and Steps are recommended where structural parts and handrails can be installed from a place of safety during the erection process. Alternatively adopt the use of fall protection equipment to restrain and limit any falls. Harnesses should be worn and used at all stages of erection of Turnlok[®] 460.

The “Work at Height Regulations 2005” specifically requires every employer to take account of the need for an easy and timely evacuation in the event of an emergency where scaffolders or operatives suffer disability or falls when suspended in a harness.

A site specific Risk Assessment and Method Statement is essential in determining the plan required for the recovery of a disabled or incapacitated person. Contractors and employers are recommended to develop their own rescue plan in accordance with the recommendations of the NASC in their documents SG4:10 and Guide to Formulating a Rescue Plan SG19:06.

All erectors should be trained in the use of special rescue equipment and ensure all equipment for rescue is available and is fit for use at all times.

NB: Legislation is constantly being updated and users are responsible to ensure that the latest and most appropriate is used at the time.



TECHNICAL SERVICES

This User Guide incorporates the basic information on the capacities and safe use of Turnlok® 460 system scaffolds for typical use situations only. For specialist arrangements and locations of use it is recommended that you contact your Turnlok® 460 supplier in the first instance, or our Consulting Structural Engineers, S-Mech Ltd, for more specialist advice, or a competent temporary works engineer. Safe working height tables are available for numerous conditions, site wind loading conditions and configurations upon request.

VR Access Solutions Ltd

Telephone: 0121 707 4928

Email: info@vrscscaffold.co.uk

S-Mech Ltd

Telephone: 01257 367 580

Email: info@s-mech.co.uk



NOTES

A series of horizontal dotted lines for taking notes, filling most of the page below the header.

