

ERECTION GUIDE

4 No 'V' PRESSINGS IN EACH CONNECTION CLUSTER



9'9" STANDARD



TOE BOARD BRACKET

1.7lb (0.8kg)



ADJUSTABLE BASE



6'6" STANDARD

9.8kg



8'0" LEDGER

9.5kg

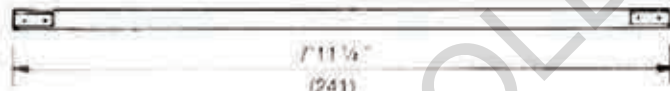

8'0" BATTEN

18.1kg



6'0" LEDGER

8.1kg



6'0" BATTEN

13.6kg



12'0" DIAGONAL BRACE



LEDGER

5.8kg



4'2" BATTEN

9.1kg



4'2" RETURN TRANSOM

12.5kg



4'2" TRANSOM

9.0kg

STAGE BRACKETS



2.3kg



5.7kg



8.7kg

Check state of ground.
Lay sole plates to prevent
settlement if necessary

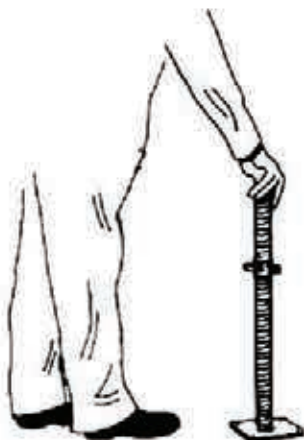

1 Starting at position of highest ground level along scaffold run place 4 adjustable bases in their approximate positions for the first bay.



2 Place a standard onto each of the two adjustable bases at one end of the bay, ensuring that the lower pockets are on the same and opposite side to the wall

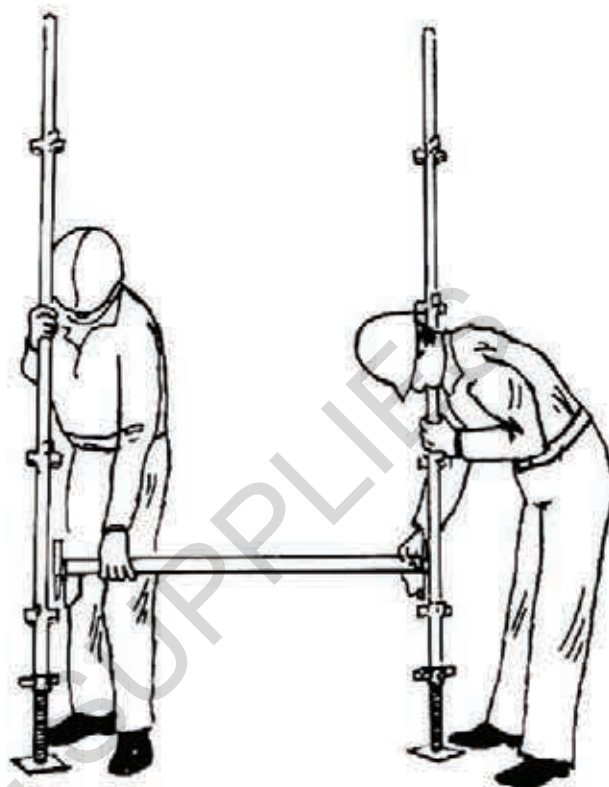

3 Insert a transom between the two standards at the lowest level. Do not tighten the wedges yet

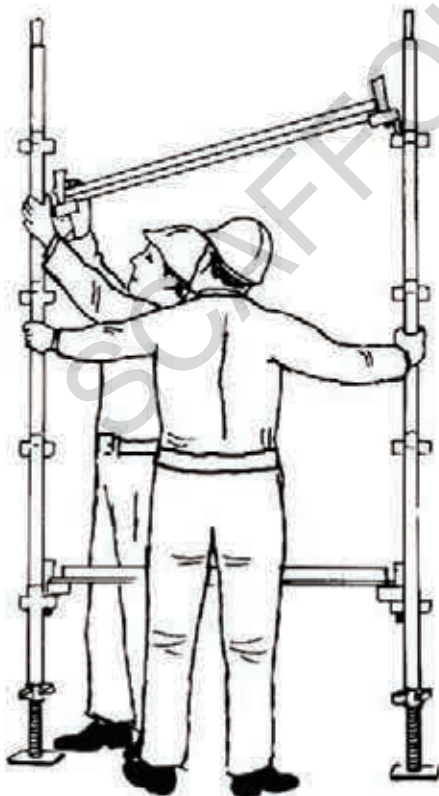

4 Insert the upper transom 3 pockets higher than the previous one.

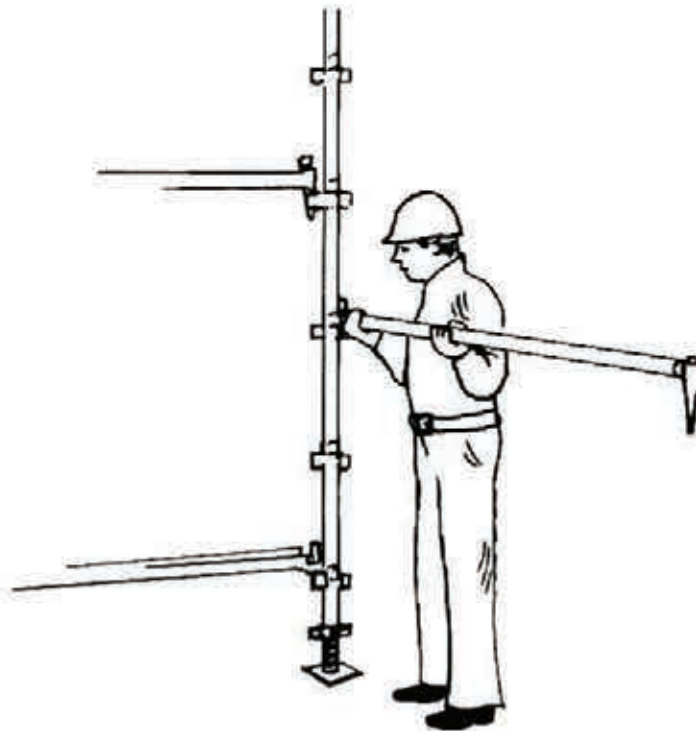

5 On the outside face of the standard link a third standard to the frame by inserting a ledger into the pockets 2 above the bottom transom. This acts as a guardrail.

Ties Every inside standard must be tied at intervals up its length of 8 metres or less for a safe working standard load of 18kN and at intervals of 6 metres or less for safe working standard load of 25kN. The first level of ties must not be higher than 4 metres above ground level and no more than 4 metres of scaffold should be ever built above the top level of ties already fixed during erection. Please contact your local depot for any additional information required.

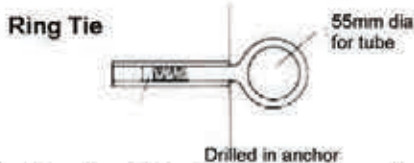
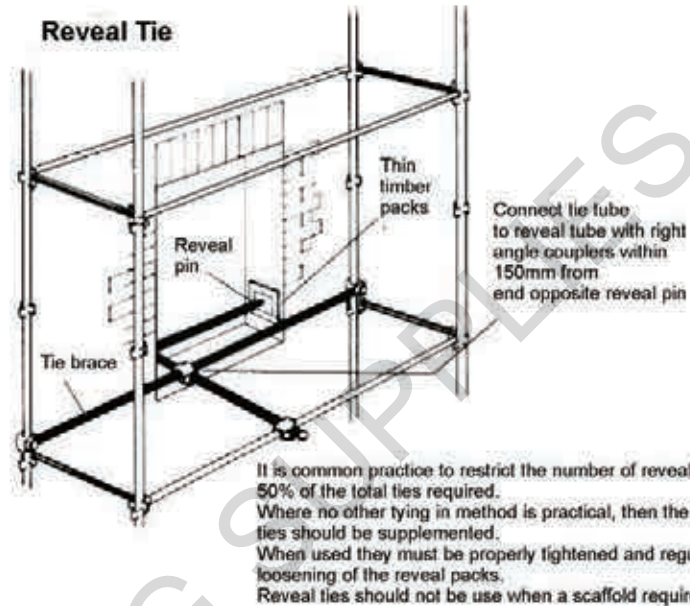
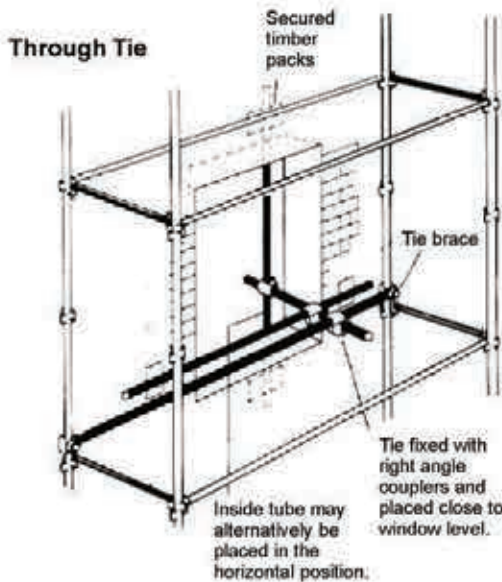

The holding value of the ring type drilled in anchor tie is always dependant on the strength value of the brickwork or building face to which it is attached. In some cases, stone facing, cavity walls, defective or unsound brickwork may not be suitable for this type of tie and in such cases the manufacturers advice should be sought. Where there is any doubt as to the efficiency of the proposed fixing locations, sample testing in the fixing areas should be carried out. Test failure loads below 12.5kN pull out indicate insufficient strength for one anchor. Existing anchors should always be checked for compatible thread sizes. When fixing to stone work, the client should be made aware of the possibility of straining from ring ties and anchors. Suppliers fixing instructions should be followed, and only the recommended fixing tools used for installation.

Drilled-in Anchor Ties

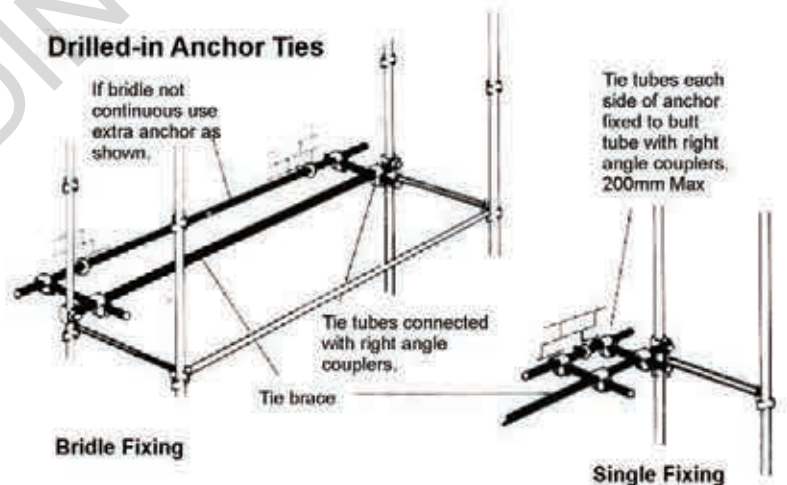

Box Tie

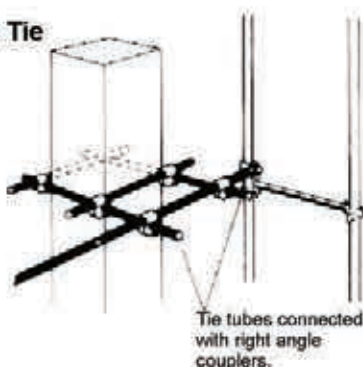

Lip Ties

These ties may be used in locations where through ties cannot be placed and are useful as stability ties over parapets or balconies, butt tubes should always be used

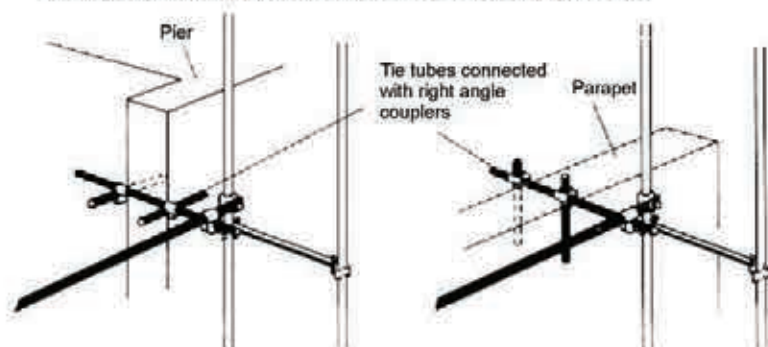

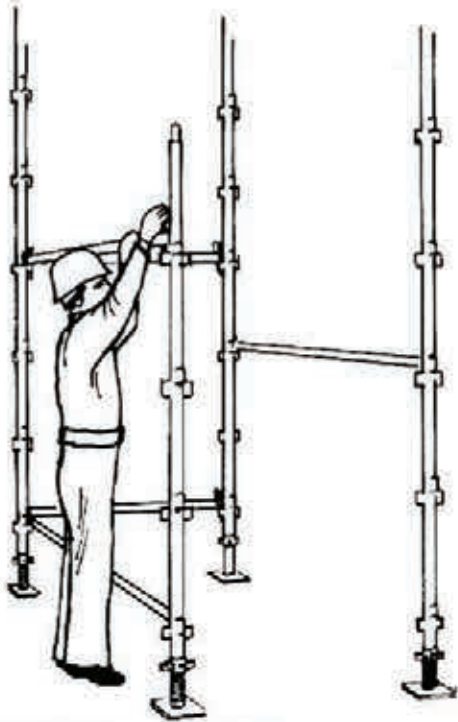

6 On the inside face of the scaffold link the fourth standard with 2 ledgers inserted at the same height as the previous transoms

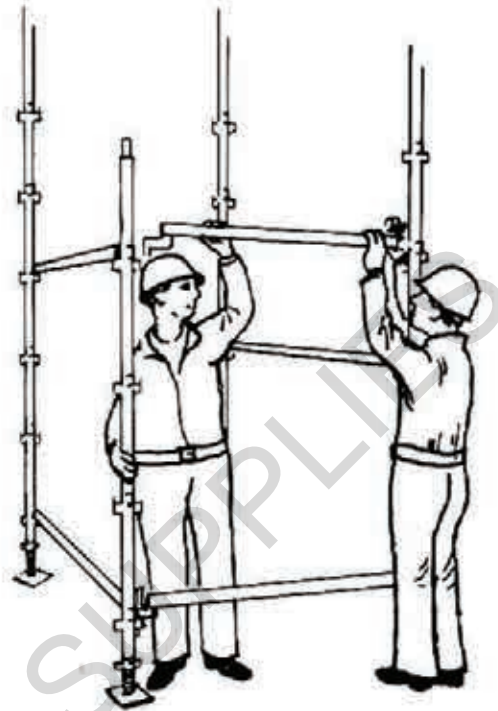

7 Complete the bay by joining the two standards with two transoms as in drawings 1-4

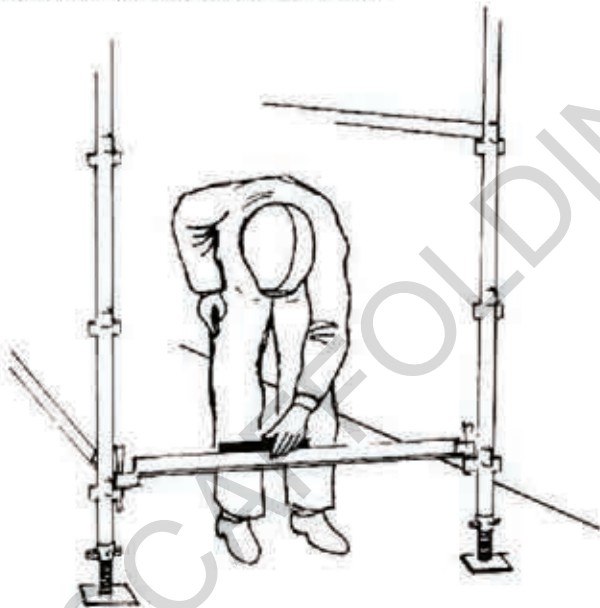

8 Level up using a spirit level. On uneven ground, always start from the standard on the highest ground

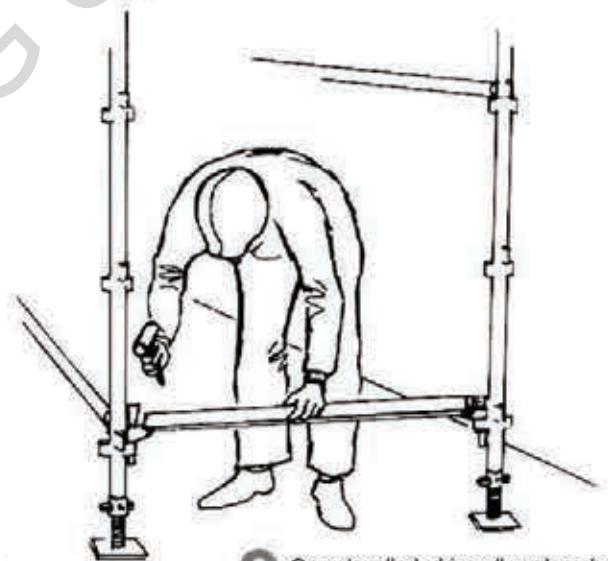

9 Once levelled, drive all wedges home.

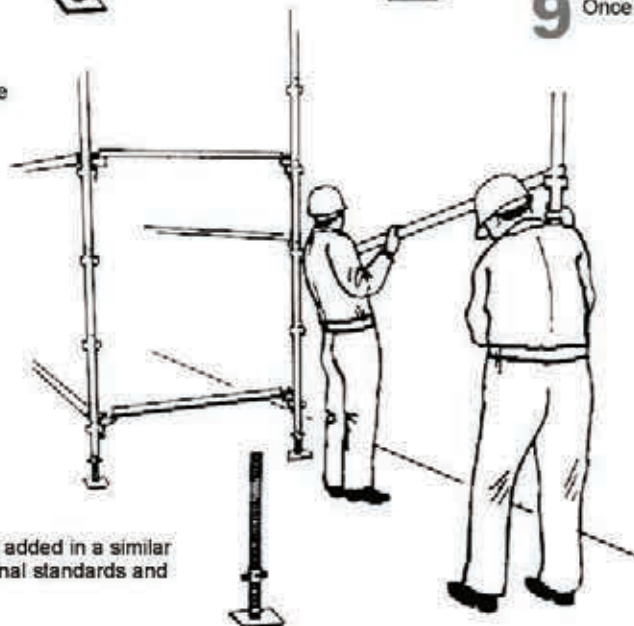

10 A second bay can now be added in a similar manner, by adding additional standards and ledgers.

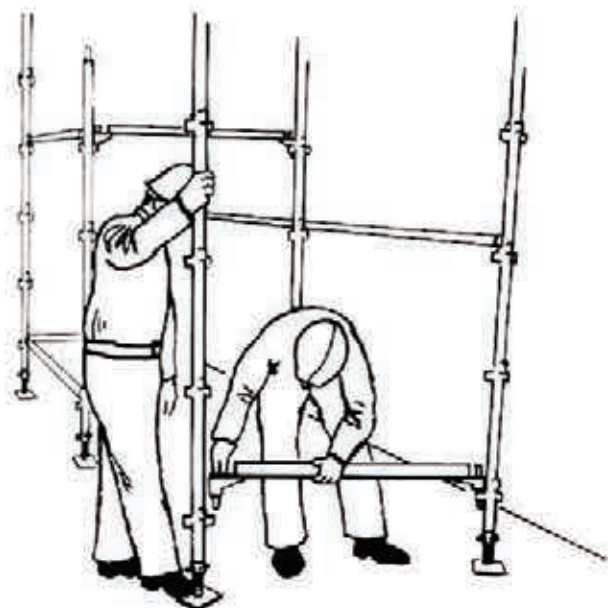

11 Further transoms are inserted in the same way as the first bay

12 Ensure everything is level before driving wedges home. Do this as each bay is completed.

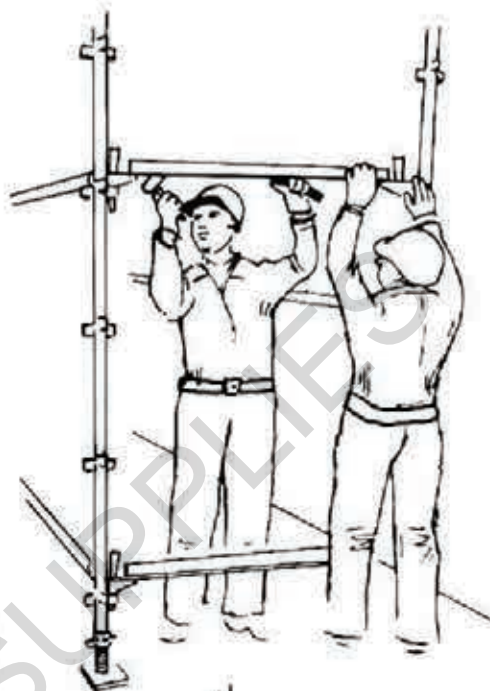

13

Before proceeding any higher, battens should be placed between transoms to provide a working platform. (These can be moved up as the scaffold progresses if decking is not needed at this level.)

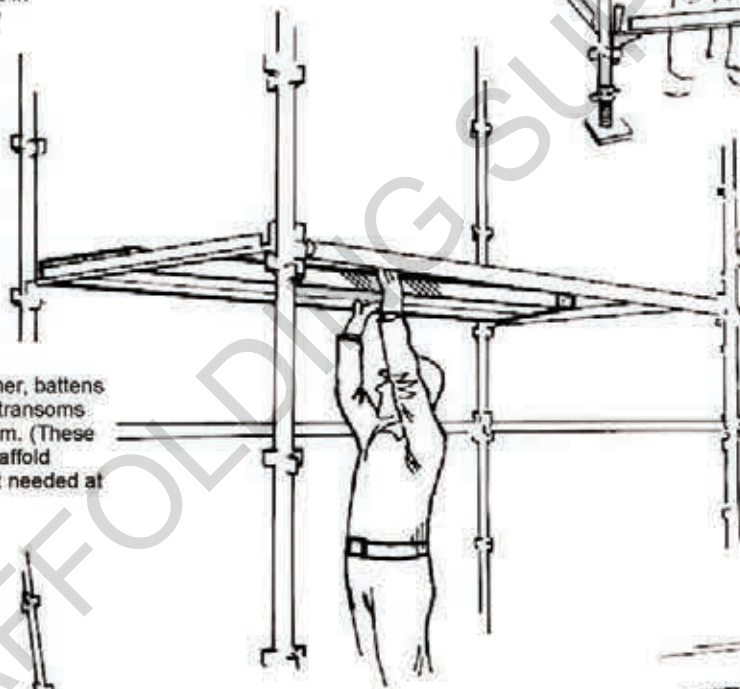

15 Add ledgers and transoms as on first bay. Continue to deck out working platforms as before ensuring the scaffold is adequately tied. (see overleaf)

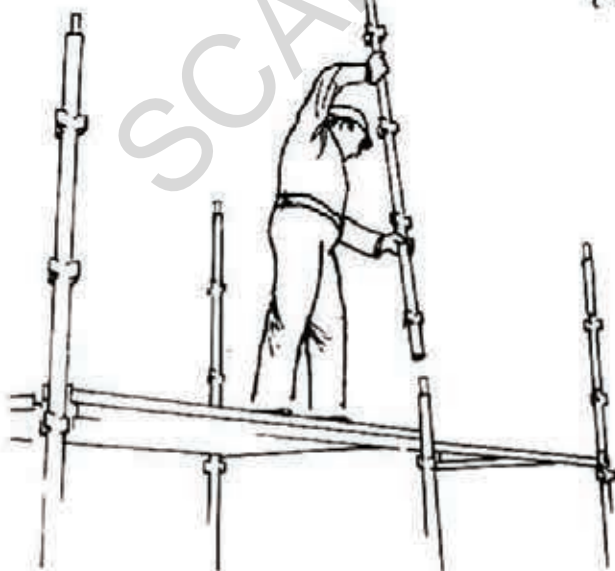

14 Once the base lift has been levelled and wedges driven home, there is no further need for subsequent lifts to be levelled. The second lift can now be commenced by placing additional standards on the base standards.

16 Fix toe boards on all working levels, including end toe boards



17 When top platform level is reached, ensure outer and end standards extend at least two pockets above the platform level so that a guardrail can be inserted.

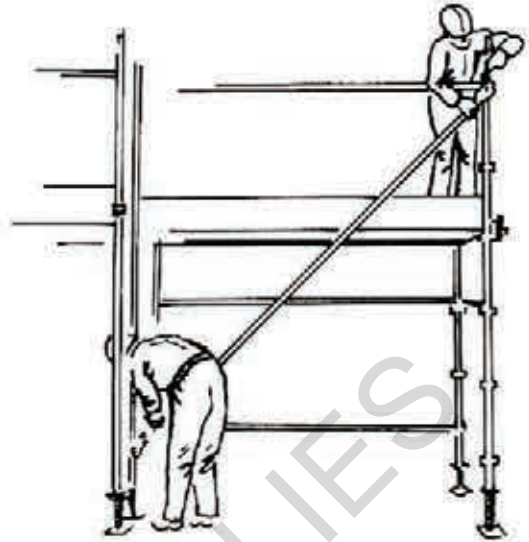

18 A face brace should be fitted at least every fourth bay, to the outside face of the scaffold only, zig-zagging up the scaffold.



19 To form a scaffold return from the first scaffold, place two return transoms on adjacent ledgers.

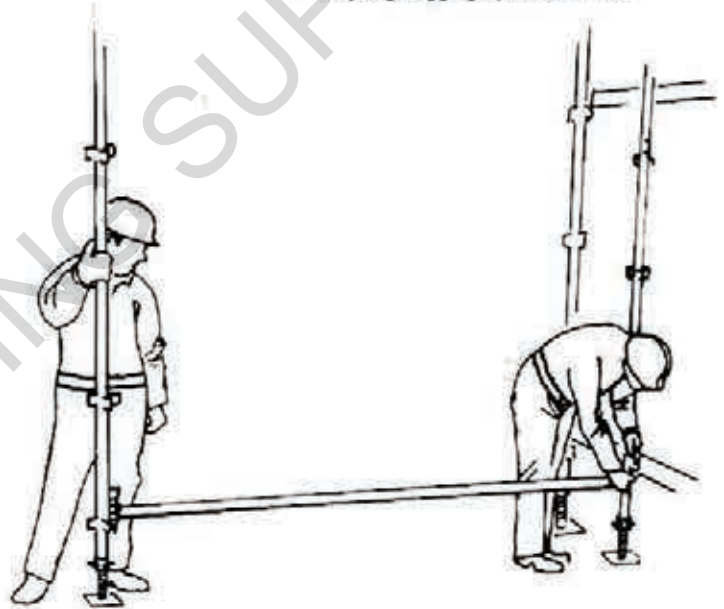

20 Add two standards on adjustable bases. Then proceed with ledgers and transoms as normal.

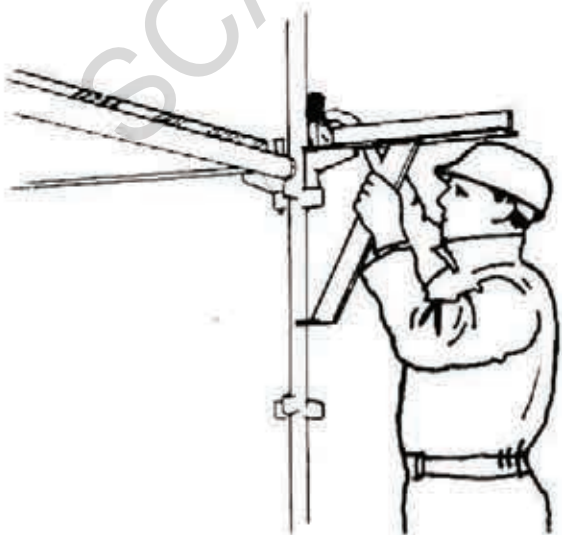

21 Where additional platform width is required, attach stage brackets to standards on the inside of the scaffold at both ends of a bay.

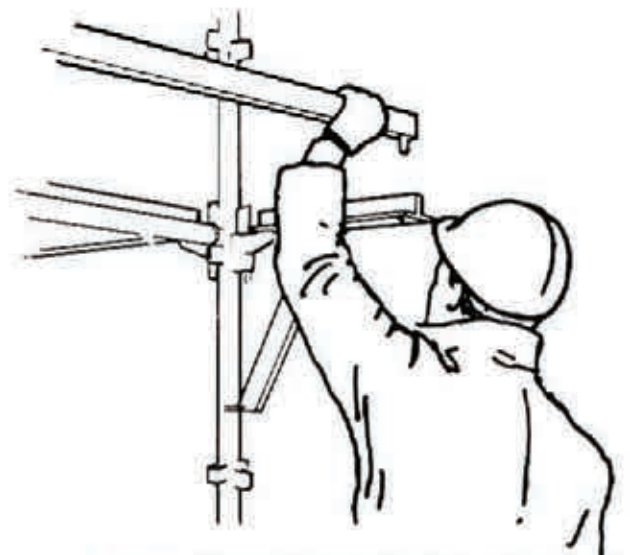

22 Connect the stage brackets by slotting in a tie bar and appropriate battens.